

(19)



Europäisches Patentamt  
European Patent Office  
Office européen des brevets



(11) EP 0 668 502 B1

(12)

EUROPEAN PATENT SPECIFICATION

(45) Date of publication and mention of the grant of the patent:  
22.05.2002 Bulletin 2002/21

(51) Int Cl.7: G01N 27/327, C12M 1/40,  
G01N 33/543, C12Q 1/00,  
C12Q 1/68

(21) Application number: 95102343.1

(22) Date of filing: 20.02.1995

(54) **Electrobiochemical method, system and electrodes for determination of a member of a recognition pair**

Elektrobiochemisches Verfahren, System und Elektroden zur Bestimmung eines Mitgliedes eines Bindungspaares

Procédé électrobiochimique, système et électrodes pour déterminer un membre d'une paire de reconnaissance

(84) Designated Contracting States:  
AT BE CH DE DK ES FR GB GR IE IT LI LU MC NL  
PT SE

(56) References cited:  
EP-A- 0 142 301 WO-A-88/08528  
US-A- 4 927 502 US-A- 5 135 876

(30) Priority: 22.02.1994 IL 10872694

(43) Date of publication of application:  
23.08.1995 Bulletin 1995/34

(73) Proprietor: YISSUM RESEARCH DEVELOPMENT  
COMPANY OF THE HEBREW UNIVERSITY OF  
JERUSALEM  
Jerusalem 92 182 (IL)

- JOURNAL OF THE AMERICAN CHEMICAL SOCIETY, vol. 115, no. 11, 2 June 1993 WASHINGTON US, pages 4937-4938, I. WILLNER ET AL. 'Photoregulated binding of spiropyran-modified concanavalin A to monosaccharide-functionalized self-assembled monolayers on gold electrodes'
- JOURNAL OF THE AMERICAN CHEMICAL SOCIETY, vol. 114, no. 8, 8 April 1992 WASHINGTON US, pages 3150-3151, I. WILLNER ET AL. 'Photoswitchable binding of substrates to Proteins: photoregulated binding of alpha-D-mannopyranose to concanavalin A modified by a thiophenfulgide dye'
- FEBS LETTERS, vol. 286, no. 1-2, 29 July 1991 AMSTERDAM NL, pages 6-8, M. HARADA ET AL. 'Photoreversible antigen-antibody reactions'
- JOURNAL OF THE AMERICAN CHEMICAL SOCIETY, vol. 114, no. 27, 30 December 1992 WASHINGTON US, pages 10965-10966, I. WILLNER ET AL. 'Mediated electron transfer in glutathione reductase organized in self-assembled monolayers on Au electrodes'
- DATABASE WPI Week 9136 Derwent Publications Ltd., London, GB; AN 91-262317 & JP-A-03 170 500 (FUJI PHOTO FILM KK), 24 July 1991

(72) Inventors:  
• Willner, Itamar  
Mevasseret Zion 90805 (IL)  
• Dagan, Arie  
Jerusalem 92341 (IL)  
• Rubin, Shai  
Mevasseret Zion 90805 (IL)  
• Blonder, Ron  
Knissa 5, Jerusalem 93507 (IL)  
• Riklin, Azalia  
Gilo, Jerusalem 93903 (IL)  
• Cohen, Yael  
Jerusalem 96674 (IL)

(74) Representative: Grünecker, Kinkeldey,  
Stockmair & Schwanhäusser Anwaltssozietät  
Maximilianstrasse 58  
80538 München (DE)

EP 0 668 502 B1

Note: Within nine months from the publication of the mention of the grant of the European patent, any person may give notice to the European Patent Office of opposition to the European patent granted. Notice of opposition shall be filed in a written reasoned statement. It shall not be deemed to have been filed until the opposition fee has been paid. (Art. 99(1) European Patent Convention).

- JOURNAL OF THE AMERICAN CHEMICAL SOCIETY, vol. 116, no. 20, 5 October 1994 WASHINGTON US, pages 9365-9366, I. WILLNER ET AL. 'Application of photoisomerizable antigenic monolayer electrodes as reversible amperometric immunosensors'

## Description

- 5 [0001] The present invention is in the field of electrobiochemical sensors and concerns a system for the determination of the presence and optionally concentration of an analyte in a liquid medium. In accordance with the present invention the analyte is determined by means of a change in the electrical response which occurs in the presence of the analyte.
- [0002] Biosensors, based on redox enzymes, that provide an amperometric response to the enzyme specific analytes, have been proposed for the determination of analytes such as glucose, lactic acid or choline (A. Heller, *Acc. Chem. Res.*, **23**, 128 (1990) and *J. Phys. Chem.*, **96**, 3579 (1992)). Another kind of assay making use of electrodes coated by redox enzymes useful for the detection of the presence and optionally concentration of an analyte in a medium has been described by I. Willner *et al.* (*J. Amer. Chem. Soc.*, **114**, 10965-10966 (1992)). This publication describes the construction of an enzyme immobilized layer on an electrode and the electrical communication between the redox enzyme with the electrode surface by means of a diffusional electron mediator or a protein-linked electron mediator.
- 10 [0003] The use of electrochemical immunoassays involving electroactive enzyme complexes as signal amplification components has been described by G.A. Robinson *et al.*, *J. Immunoassay*, 1-15 (1986) and in European Patent Application No. 85303367.8 (Publication No. EP 167248). This immunoassay, which involves the probing of enzyme complexes, has a major drawback in that the activity diminishes with time as well as upon the addition of ingredients which are required for the enzymatic reactions.
- 15 [0004] The use of a homogeneous electrochemical immunoassay is disclosed in U.S. Patent No. 5,198,367. This assay involves the preparation of an antigenic redox active protein complex, wherein the electrical communication of the complex with the electrode in the presence of the respective antibody is controlled by the analyte in the solution. The preparation of the three component antigenic-redox relay protein complex is difficult. Furthermore, all electrochemical immunoassays are single-cycle sensing devices and cannot be reused: after a single measurement the activity of the probing complexes is terminated. Itamar Willner *et al.* describes in *J. Am. Chem. Soc.* 1993, 115, 4937 to 4938 the photoregulated binding of spiropyran-modified Concanavalin A to a monosaccharide layer immobilized on the surface of an electrode. Concanavalin A is modified by incorporating a spiropyran moiety (see Compound 1a), and binding of the thus obtained substrate to the monosaccharide monolayers organised on gold electrodes were studied.
- 20 [0005] Joseph D. Andrade *et al.* discloses the linking of the immobilized member of a recognition pair to a photosensitive molecule. In one state the photosensitive molecule stencally blocks the binding site of the immobilized member, while when in the other state, it does not.
- [0006] Electrobiochemical sensors for the detection of redox inactive biomolecules and particularly biomolecules appearing in sub-micromolar and nanomolar concentration ranges, have important potential applications in diagnostics, food analysis and environmental analysis. Examples can range from detecting antibodies and antigens to tracing undesirable metabolites and herbicides to identifying the presence of toxins and viruses.
- 25 [0007] It is the object of the present invention to provide an electro-biochemical system for the determination of the presence and optionally the concentration of an analyte in a liquid medium, the analyte being a member of a recognition pair, said electrobiochemical system being substantially reversible and reusable.
- [0008] It is furthermore the object of the present invention to provide electrodes for use in the above systems.
- [0009] It is still a further object of the present invention to provide a process for the preparation of such electrodes.
- 30 [0010] The object is achieved by an electrobiochemical system for the determination of the presence and optionally concentration of an analyte in a liquid medium, the analyte being one member of a recognition pair, the system comprising:

45 (i) an electrode having immobilized thereon the other member of a recognition pair, being immobilized on the surface of the electrode by means of a linking group, such that the presence of said analyte in the medium results in formation of pair complexes on the electrode, wherein the immobilized member of the recognition pair has or is linked to a group reactive to exposure to light energy; said group having a first and a second state and is capable of being converted from the first state to the second state by exposure to irradiation of light of a first wavelength and from the second to the first state by exposure to irradiation of light of a second wavelength; the exposure inducing a conformational change in the binding site of the immobilized member resulting in a change in affinity of the immobilized member for binding to said analyte, whereby in the first state said immobilized member has a high affinity of binding to said analyte such that the analyte remains essentially bound to the immobilized member and in said second state said immobilized member has a low affinity of binding to said analyte, such that the bound analyte is readily dissociated; and

50

55 (ii) redox molecules which can change their redox state by accepting electrons from or donating electrons to the electrode; formation of a pair complex on the electrode brings to a change in the electrical response of the system, whereby the presence and optionally concentration of said analyte in the medium can be determined.

[0011] In the following description the term "electrical response" will be used to denote the current-voltage behavior of the electrode, e.g. the current or charge flow under a certain potential. The electrical response may be determined by measuring current or charge flow.

5 [0012] In accordance with the present invention a novel electrobiochemical system and an electrode for use in the biochemical system is provided. The system in accordance with the invention is capable, by means of a change in electrical response of an electrobiochemical electrode, to determine the presence and optionally the concentration of an analyte in a liquid medium. The analyte forms a part of a recognition pair, for example, an antigen-antibody, ligand-receptor, sugar-lectin, biotin-avidin, enzyme-substrate, oligonucleotide-DNA, oligonucleotide-protein, and oligonucleotide-cell.

10 [0013] The immobilized member may be a member of any specific recognition pair. Examples of such recognition pairs are antigen-antibody, sugar-lectin, ligand-receptor, biotin-avidin, enzyme-substrate, oligonucleotide-DNA, oligonucleotide-protein, and oligonucleotide-cell. When one of such a pair, e.g. an antigen, is immobilized on the electrode, it then is suitable for the determination of the other member of the recognition pair in a liquid medium, e.g. in the antibody.

15 [0014] As a result of binding of the analyte onto the electrode and the formation of a pair complex consisting of the two members of the recognition pair immobilized on the electrode, there results a change in electrical response of the electrodes which provides an indication of the presence of said analyte in the medium. The degree of change in the electrodes' electrical properties correlates with the extent of binding of said analyte to the immobilized member and is dependent upon the concentration of said analyte in the medium surrounding the electrode. Thus, the extent of change in the electrical properties may be used, by a preferred embodiment of the invention, as an indication of the concentration of said analyte in the medium.

20 [0015] In the following description the term "determination" will be used collectively to denote both determination of only the presence or determination of both the presence and concentration in a liquid medium.

[0016] The invention is useful for the determination of an agent in a biological sample, an aquatic sample or food sample. The determination may be carried out by one of two modes to be referred to herein as the "direct mode" and the "indirect mode". In accordance with the direct mode, the agent in the biological sample is the analyte of the system. In accordance with the indirect mode, the agent and the analyte are different; the analyte which is determined in said system serves as a measure for the determination of the agent in said sample.

25 [0017] The determination of an agent in a biological sample in accordance with the direct mode is essentially a single step procedure in which the electrode in said system is challenged with the tested biological sample or with an appropriate fraction thereof which contains said agent. An example of the direct mode of the invention is the determination of an antibody in a biological sample wherein the electrode has immobilized thereon an antigen to which said antibody specifically binds; or the determination of an antigen by the use of an electrode having immobilized thereon an anti-antigen antibody.

30 [0018] In accordance with the indirect mode, the agent in the biological sample is not determined directly but rather indirectly by an essentially two-step procedure. In accordance with this mode the biological sample is reacted, in a first step, with a reagent solution. This reaction brings to either formation of said analyte in a manner dependent on the concentration of said agent in said sample; or reduction in the concentration of said analyte present *a priori*. Thus, depending on the type of reaction, the concentration of the analyte will be in a direct or inverse correlation to the concentration of said agent in said sample. In a second step, the electrode is challenged with the reaction product of the first step and the analyte which is then determined will serve as an indirect measure of said agent in said sample.

35 [0019] By one embodiment of the indirect mode, the analyte is a molecule which binds to the tested agent. The reagent solution of this embodiment comprises the analyte and following the reaction between the reagent solution and the biological sample the analyte will bind to said agent. Consequently, the concentration of the free analyte in the solution will be reduced, i.e. the concentration of the analyte to be subsequently determined will be in an inverse correlation to the concentration of said agent in said sample.

40 [0020] A specific example is the use of immobilized antigen in order to determine an identical or related antigen in a biological sample to be tested. In accordance with this specific example, the biological sample, e.g. a plasma sample is first reacted with a reagent solution comprising an antibody which specifically binds to the antigen to be determined. After binding, the concentration of free antibody becomes lower. Following an incubation period, an electrode on which there is immobilized the said antigen is challenged with the reacted solution, and the determination of the free antibody serves then as an indication of said antigen in the tested biological sample. As will no doubt be appreciated by the artisan, the concentration of said free antibody will be in opposite correlation to the concentration of the antigen in the tested sample.

45 [0021] Furthermore, as will also be appreciated, an antibody in a tested biological sample rather than an antigen may be determined in an analogous manner, *mutatis mutandis*.

50 [0022] In accordance with another embodiment of the indirect mode, the tested agent is an enzyme and the analyte is either a molecule which is broken down by the enzyme or a molecule which is catabolized by the enzyme from another, precursor molecule. In the first case, the reagent solution comprises said analyte and following reaction with

the tested sample the concentration of the analyte will be reduced in correlation with the enzyme's concentration in the sample. In the latter case, the reagent solution will comprise said precursor molecule and following reaction with the tested sample, the analyte will form and its concentration will then be in direct correlation to the enzyme's concentration in the sample.

5 [0023] In accordance with a further embodiment of the indirect mode, the reagent solution comprises an enzyme which converts the agent in said sample into said analyte.

[0024] In the above two embodiments, the enzyme of the testing sample in the first case or the enzyme of the reagent solution in the second case, should be removed after performance of the first step of the procedure.

10 [0025] By one embodiment of the invention, the redox molecules are freely tumbling in the medium. In accordance with this embodiment, upon binding of said analyte to the immobilized member the surface of the electrode is insulated or partially insulated towards the redox molecules depending upon the concentration of said analyte in liquid medium.

[0026] In accordance with another embodiment of the invention, the redox molecule is linked to analyte molecules (hereinafter at times "*modified analyte*"). In accordance with this embodiment, the modified analyte and the analyte originating in the tested sample compete on binding to the immobilized member. In the presence of relatively large concentrations of said analyte in the sample, there will be little binding of the modified analyte to the electrode immobilized member. In contrast, in the case of low concentrations of the analyte to be determined in a sample there will be extensive binding of the modified analyte to the immobilized member on the electrode. Binding of the modified analyte to the immobilized member brings the redox molecule into proximity with the electrode material which facilitates electron exchange between the two. Thus, upon binding of the modified analyte to the immobilized member, there will be an increase in the electrical response of the electrode. This increase will be in reverse correlation to the concentration of the analyte in the tested sample such that a large increase will indicate a small concentration of the analyte and *vice versa*.

[0027] In accordance with one variation of the above embodiment, the electrode is simultaneously challenged by the modified analyte and with the analyte to be determined in the sample.

25 [0028] In accordance with another variation of carrying out this embodiment, the electrode is first challenged with the sample in which the presence of the analyte is to be determined and subsequently challenged with a solution containing the modified analyte.

[0029] The electrode material may be selected from a variety of conducting substances, particularly such having the capability to associate chemically with, attach or chemisorb a sulphur-containing moiety. The electrode material is preferably made of or coated by metals such as gold, platinum, silver or copper. In another embodiment the electrode may comprise of conducting glass electrodes, for example, Indium tin oxide (ITO) with functionalized alkoxy silanes associated with the electrode's surface (Silanization of an ITO electrode can be adhered by refluxing the electrode in an argon atmosphere with 3-aminopropyltriethoxysilane in dry toluence and then drying in an oven).

35 [0030] The redox molecule is a molecule capable of changing its redox state by accepting or donating electrons. An example of a redox molecule is  $K_4Fe(CN)_6$  [ferricyanide/ferrocyanide]. Another example is N-methyl-N'-carboxymethylene-4'4'-bipyridinium.

[0031] The immobilized member is immobilized on the surface of the electrode by means of a linking group, which typically may have the following general formula (I):

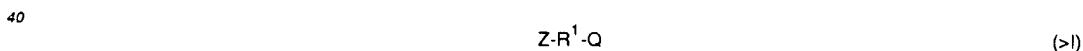

wherein:

45 Z in case where the electrode material is one of said metals, represents a sulphur-containing moiety which is capable of chemical association with, attachment to or chemisorption onto said metal; and in case where the electrode material is glass, represents methoxy or alkoxy silane residues which are capable of chemical association, attachment to or chemisorption onto said glass;

R<sup>1</sup> represents a connecting group;

50 Q is a functional group which is capable of forming a covalent bond with a moiety being a member of a recognition pair.

[0032] Z where the electrode material is a metal may for example be a sulphur atom, obtained from a thiol group or a disulphide group, a sulphonate or sulphate groups.

55 [0033] R<sup>1</sup> may be a covalent bond or may be a peptide or polypeptide or may be selected from a very wide variety of suitable groups such as alkylene, alkenylene, alkynylene phenyl containing chains, and many others.

[0034] Particular examples of R<sup>1</sup> are a chemical bond or a group having the following formulae (IIa), (IIb) or (IIc)

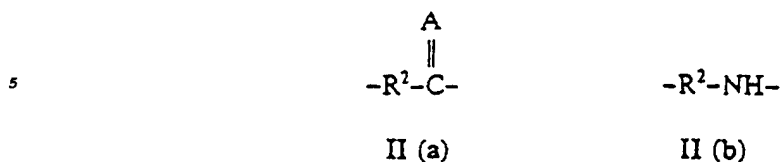

10

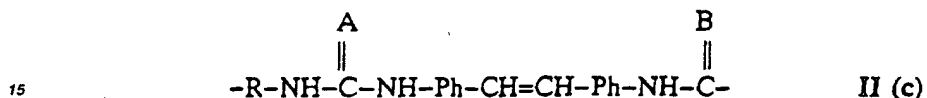

wherein

20 **R<sup>2</sup> or R<sup>3</sup>** may be the same or different and represent straight or branch alkylene, alkenylene, alkynylene having 1-16 carbon atoms or represent a covalent bond,

**A and B** may be the same or different and represent O or S,

**Ph** is a phenyl group which is optionally substituted, e.g. by one or more members selected from the group consisting of SO<sub>3</sub><sup>-</sup> or alkyl groups.

25

**[0035]** Q may for example be a functional group capable of binding to a carboxyl residue of a member of a recognition pair such as an amine group, a carboxyl group capable of binding to amine residues of the member of a recognition pair; an isocyanate or isothiocyanate group or an acyl group capable of binding to an amine residue of the member of a recognition pair; or a halide group capable of binding to hydroxy residues of the protein or a polypeptide. Particular examples are the groups -NH<sub>2</sub> - COOH; -N=C=S; N=C=O; or an acyl group having the formula -R<sup>a</sup> - CO-G wherein G is a halogen such as Cl or OH, OR<sup>b</sup>, a

35

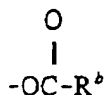

group or a

40

45

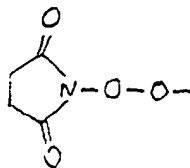

50 group; R<sup>a</sup> and R<sup>b</sup> being, independently a C<sub>1</sub>-C<sub>12</sub> alkenyl, alkenyl or a phenyl containing chain which is optionally substituted, e.g. by halogen.

**[0036]** Particular examples of such a linking group are cysteamine (III), cystamine (IV) and cysteic acid N-hydroxy-succinimide ester (V) having the formulae:

55

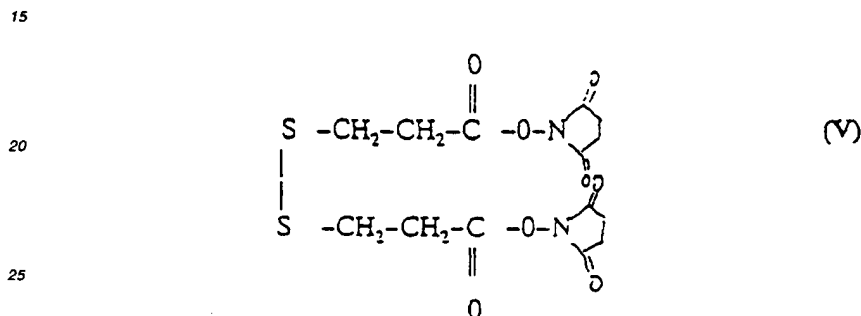
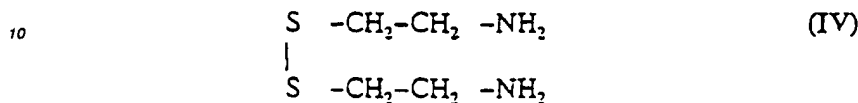
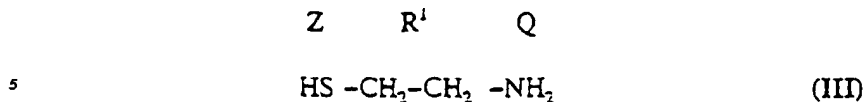

30

[0037] Binding of two members of a binding couple to one another is a high affinity binding, namely the two members do not dissociate easily from one another and even after the electrode is rinsed, the analyte still remains substantially bound to the immobilized member. In order to re-use the electrode for a further measurement, there is a need to dissociate the analyte from the immobilized member and remove the analyte from the system. The dissociation is achieved by means of a group, attached to the member immobilized on the electrode which has two isomerization states and is capable of switching reversibly between its two states by exposure to light energy at two different wavelengths. Such a group will have a first and second isomerization state and by reversibly switching from one state to the other will cause a conformational change in the immobilized member which will bring about a change in the binding of affinity of the immobilized member to said analyte. Such a conformational change may, for example, be the occlusion of the binding site or a conformational change within the binding site which will cause a reduction in the binding affinity of the immobilized member to the analyte which may hereinafter be defined as change or switch from a state of high affinity to a state of low affinity.

40

[0038] In the first state, the immobilized member will have a high affinity to binding to said analyte and after performing a measurement, the electrode will be treated so that said group will switch to the second state and consequently said analyte will dissociate from the immobilized member. After removal of said analyte from the system, typically by rinsing and washing away of the rinsing solution, the electrode will be further treated so that said group switches back to said first state, whereby the electrode will be ready for re-use.

45

[0039] The switching between the two states is achieved by exposure to light of an appropriate wavelength within the infra red, visible or ultra violet range. The reactive group will switch from said first state to said second state by exposure to light energy at a first wavelength and from a second state to said first state by exposure to a second, different than the first, wavelength. It is also possible that one of the switches will be achieved by mild thermotreatment.

50

[0040] Thus there is provided a system wherein the immobilized member of the recognition pair has or is linked to a group reactive to exposure to light energy; said group having a first and a second state and is capable of being converted from the first state to the second state by exposure to irradiation of light of a first wavelength and from the second to the first state by exposure to irradiation of light of a second wavelength; the exposure inducing a change in affinity of the immobilized member for binding to said analyte, whereby in the first state said immobilized member has a high affinity of binding to said analyte such that the analyte remains essentially bound to the immobilized member and in said second state said immobilized member has a low affinity of binding to said analyte, such that the bound analyte is readily dissociated.

55

[0041] There is also provided according to another embodiment of the invention a system wherein the said switching

from the first state to the second state is by exposure to light energy but the switching from said second state to said first state is by mild thermal treatment.

**[0042]** The sensitivity of the system of the invention may be increased by the use of analyte molecules which are conjugated or complexed with a large molecule or a group of molecules (hereinafter at times "complexed analyte").  
 5 The binding to the immobilized member, the complexed analytes sterically impede access of redox molecules to the electrode material. By one embodiment, this is achieved by the use of analytes conjugated to a large molecule or complex of molecules, such as for example, an anti-antibody to an analyte antibody, an antibody to a protein analyte, and the like.

**[0043]** By another embodiment, after the analyte is allowed to bind to the immobilized member, the electrode is  
 10 challenged with agents capable of binding to the bound analyte, whereby the agents complexed with the bound analyte give rise to steric impedance. In order to increase the steric impedance, after the formation of an initial complex, the electrode is reacted with anti-agents which bind or are complexed to the agents already bound or complexed to the immobilized analyte, e.g. an anti-antibody and this brings about an increase in the size of the complex and hence also an increase in the steric impedance.

**[0044]** By increasing the sensitivity of the system in the manner described above, a change in the electrical response of the electrode can be measured after binding of only a few analyte molecules to the electrode.

**[0045]** The present invention provides also a substantially reusable electrode for use in the electrochemical system according to any one of claims 1 to 8, for the determination of the presence and optionally concentration of an analyte in a liquid medium, the electrode comprising an electrode material capable of electrical communication with a redox molecule; there being immobilized on the electrode material a layer of a member of a recognition pair, being  
 20 immobilized on the surface of the electrode by means of a linking group, the other member of the pair being said analyte; the electrical communication between the redox molecule and the electrode material being modified by binding of said member to said analyte; the immobilized member has or is linked to a group reactive to exposure to light energy, said group having a first and a second state and is capable of being converted from the first state to the second state  
 25 by exposure to irradiation of light of a first wavelength and from the second to the first state by exposure to irradiation of light of a second wavelength; the exposure inducing a conformational change in the binding site of the immobilized member resulting in a change in affinity of the immobilized member for binding to said analyte, whereby in the first state said immobilized member has a high affinity of binding to said agent such that the bound analyte is not readily dissociated and in said second state said immobilized member has a low affinity of binding to said analyte, such that  
 30 the bound agent is readily dissociated and can be removed from the system and the electrode can then be exposed to light of a second wavelength inducing a change to said first state, whereby the electrode will be ready for re-use, whereby the presence and optionally the concentration of said analyte in a medium surrounding the electrode can again be determined.

**[0046]** The group responsive to exposure to light energy is a compound having more than one stable structure or isomeric state which is sensitive to irradiation of light at a first wavelength such that it changes from a first state to a second state. This change in state is reversible as the group is also sensitive to irradiation of light at a second wavelength (or by thermal treatment) such that it changes from the second state to the first state. Typically, the first and second wavelengths are within the infra red, visible or ultra violet regions.

**[0047]** Examples of five families of compounds which could be used to make the group can be seen in Fig. 19 -  
 40 structures (1) to (5) inclusive, namely: azobenzenes (1), spiropyranes (2), fulgides (3), thiophenefulgides (4) or malachite green (5). Examples of the structural change in three of these five families of compounds which occurs upon their exposure to irradiation of light energy of an appropriate wavelength is illustrated by structures (6) to (8) of Fig. 19. Specifically item (6) exemplifies azobenzenes, structure (7) spiropyranes and structure (8) malachite green. These compounds all require structural modification to prepare a group which can be linked to the member of a recognition pair to be immobilized on the surface of the electrode. Accordingly, in the preferred embodiment these compounds are modified chemically to form active esters, amine, carboxylic acid, or halide derivatives. The presence of these moieties facilitates linkage of the group to the member of the recognition pair. Structures (13) and (14) illustrate both the appropriate wavelengths of light energy required to change spiropyran from a first state (a) to a second state (b) in which it is in its merocyanine form and also the structures of the first and second isomer states with and without the N-hydroxysuccinimide ester moiety.  
 50

**[0048]** The examples of photoisomerizable active esters which can be seen in Fig. 19 are N-hydroxyoxsuccinimide ester of N-propionic acid spiropyran (15), N-hydroxyoxsuccinimide ester of 4-carboxy azobenzene (16) and N-hydroxyoxsuccinimide, ester of thiophenefulgid (17).

**[0049]** The present invention also provides a process for preparing the above electrode, comprising:

- 55 (a) immobilizing said connecting group onto the electrode material by chemical association attachment or chemisorption of the sulphur-containing moiety or functionalized alkoxysilane to the metal or glass electrode material, respectively; and



(b) binding the member of the recognition pair to be immobilized to said functional group of the connecting group.

[0050] Steps (a) and (b) may also be reversed so that immobilization takes place before binding.

[0051] The present invention further provides a process for preparing the above electrode incorporating the group reactive to light energy comprising:

(a) immobilizing said linking group onto the electrode material by chemical association attachment or chemisorption of the sulphur-containing moiety or functionalized alkoxy silane to the metal or glass electrode material, respectively;

(b) chemically modifying a member of said recognition pair with a photoisomerizable group whereby the modified member changes its bonding affinity to the other member of the recognition pair by exposure to light energy; and  
(c) binding the modified member of the recognition pair to said functional group of the linking group immobilized on the electrode.

[0052] Steps (b) and (c) can be reversed such that the isomerizable group is bound to the member of the recognition pair after it has been immobilized in the electrode and so can steps (a) and (b).

[0053] The invention will now be illustrated in the following description of some specific embodiments, with occasional reference to the annexed drawings, without prejudice to the generality of the foregoing.

[0054] In the drawings:

Fig. 1 is a schematic representation of the surface of an electrode according to an embodiment in accordance with the direct mode of the invention in which a member of a recognition pair is immobilized on the surface of an electrode (a) that is immersed in liquid medium containing redox molecules  $R^+/R$  and is then challenged with a solution containing an unknown concentration of the analyte member of the recognition pair which then binds to its counterpart member of the recognition pair immobilized on the said surface (b). The binding brings to a decrease of the electric response.

Fig. 2 is a schematic representation of another embodiment of the direct mode of the invention in which a member of a recognition pair is immobilized on the surface of an electrode (a) and is challenged sequentially by a solution containing an unknown concentration of the analyte member of the recognition pair (step (1)). Binding of some of the immobilized sites by the analyte takes place (b) and the electrode is then challenged by the analyte modified by linking thereto a redox molecule R (step (2)). Binding by the said modified analyte (c) produces an electrical response (d): the magnitude of the electrical response depends on the number of vacant sites remaining after step 1 which in turn depends on the analyte's concentration.

Fig. 3 is a schematic representation of a variation of the embodiment of Fig. 2, in which a member of a recognition pair is immobilized on the surface of an electrode and is then challenged simultaneously with both (i) a solution containing an unknown concentration of the analyte member of the recognition pair and (ii) the analyte member modified by linking thereto a redox molecule (a). Competitive binding dependent upon the respective concentrations of analyte and modified analyte takes place to produce an electrical response (b) leading eventually to an electrical response (c), which depends on the concentration of (i).

Figs. 4 and 5 are schematic representations of embodiments similar to Figs. 2 and 3, respectively, in which the analyte of Figs. 2 and 3 is the immobilized member whereas the immobilized member of Figs. 2 and 3 is now the analyte.

Fig. 6 is a schematic representation of a further embodiment of the direct mode of the invention in which the immobilized member is modified by linking thereto a group reactive to exposure to light energy. This group has two isomerization states, indicated in the drawings as A and B and as illustrated in Fig. 6(c) it switches from A to B by exposure to light energy  $h\nu_1$ , and switches back from B to A by exposure to light energy  $h\nu_2$ . By exposure to light of an appropriate wavelength, the modified immobilized member undergoes a conformational change which changes its affinity to bind to the analyte and consequently, after binding of the analyte, it can be released and after rinsing converted to its original state for reuse. Figs 6(a) and (b) illustrate the operational cycle, the difference between these two figures being in that the roles of the analyte and the immobilized member in Figs. 6(a) and (b) are reversed, i.e. the analyte of Fig. 6(a) is the immobilized member in Fig. 6(b), and *vice versa*.

Fig. 7 shows an embodiment in accordance with the indirect mode of the invention for the determination of an agent in a biological sample which is identical to the immobilized member. In this embodiment the unknown sample is first reacted with the analyte and then the determination of the analyte serves as an indirect measure for the agent in the biological sample.

Fig. 8 is a schematic representation of an embodiment in accordance with the indirect mode of the invention, similar to that of Fig. 7 with the difference being that in this case the tested agent is not identical to the immobilized member but has similar binding affinity to the analyte as the immobilized member.

- Fig. 9 is a schematic representation of an embodiment in accordance with the indirect mode of the invention for the determination of an enzyme capable of breaking the analyte to products which do not bind to the immobilized member. Following reaction of the analyte with the unknown sample, part of the analyte is degraded, depending on the amount of the enzyme in the biological sample and determination of the analyte then allows an indirect determination of the enzyme in the sample.
- Fig. 10 illustrates an embodiment in accordance with the indirect mode of the invention similar to the embodiment of Fig. 9, the difference being that the enzyme catabolizes a reaction in which precursor analyte is converted to the analyte which is then determined in a system. Here also, the determination of the analyte allows an indirect determination of the enzyme in the biological sample.
- Fig. 11 illustrates a further embodiment of the indirect mode of the invention in which the analyte is a product of an enzymatic reaction in which a precursor analyte present in a biological sample is converted by an enzyme to the analyte which is then determined in a system; the determination of the analyte provides an indirect measure of the precursor analyte, which is the tested agent in the biological sample.
- Fig. 12 illustrates an embodiment of the invention wherein the sensitivity is increased by forming a molecular complex on the bond analyte.
- Fig. 13 illustrates the manner of modification of a gold electrode as described in Example 1.
- Fig. 14(a) shows a cyclic voltammogram response of the DNP electrode of Example 1 in the absence (curve a) of and at different concentrations of an anti-DNP antibody (curves b-e).
- Fig. 14(b) shows the change in the current response at the peak ( $\Delta I_{pc}$ ), at various antibody concentrations versus control (without antibody).
- Fig. 15 illustrates the manner of immobilization of a fluorescein monolayer on a gold electrode as described in Example 2.
- Fig. 16 shows the change in maximal current ( $\Delta I_{pc}$ ) at various anti-fluorescein antibody concentrations as described in Example 2.
- Fig. 17 shows an antigenic peptide (Fig. 17(a)) which was immobilized onto a gold electrode (Fig. 17(b)) in a manner described in Example 3.
- Fig. 18 shows cyclic voltammograms of a gold electrode modified with the antigenic peptide of Fig. 17, at times equal 0 (curve A), after 3 min. (curve B), after 5 min. (curve C) and after 35 mins. (curve D) following addition of an anti-peptide antibody.
- Fig. 19 shows the formula of the compounds 1-17 referred to in the text.
- Fig. 20 illustrates the procedure of immobilization of a monosaccharide  $\alpha$ -D-Mannopyranose layer on the surface of a gold electrode as described in Example 4.
- Fig. 21 shows cyclic voltammograms of a gold electrode modified with an  $\alpha$ -D-mannopyranoside monosaccharide layer, as illustrated in Fig. 19, following challenging of the electrode with different concentrations of Concanavalin A in the presence of constant concentration of 25  $\mu$ M of Concanavalin A modified by linking thereto a redox molecule being N-methyl-N'-carboxymethylene-4,4'-bipyridinium. The concentrations of unmodified Concanavalin A were 0 (curve a), 2.5  $\mu$ M (curve b), 5  $\mu$ M (curve c), 10  $\mu$ M (curve d) and 20  $\mu$ M (curve e).
- Fig. 22 shows a calibration curve of the decrease in charge transfer as a function of unmodified Concanavalin A concentration in the system of Fig. 20.
- Fig. 23 shows the cathodic current of the  $\alpha$ -D-mannopyranoside monolayer electrode illustrated in Fig. 20 in the presence of a constant concentration of Concanavalin A modified by linking thereto a redox molecule in the presence of increasing concentrations of unmodified Concanavalin A.
- Fig. 24 shows the amperometric response of electrodes with an immobilized mannose layer, upon exposure to a Concanavalin A solution comprising different concentrations of  $\alpha$ -D-mannopyranoside.
- Fig. 25 illustrates the immobilization of a dinitrospiropyran (DNSP) monolayer on a gold electrode as described in Example 6.
- Fig. 26(a) shows cyclic voltammograms of an electrode having an immobilized layer of DNSP following 16 mins. incubation with anti-DNP antibody: Fig. 26(a) are results of an electrode with the DNSP in its original state, whereas Fig. 26(b) is the same electrode after photoisomerization of the DNSP to the zwitterionic merocyanine configuration.
- Fig. 27 shows the pick current developed in the electrode of Fig. 25 following incubation with an anti-DNP antibody at two different isomerization states of the immobilized antigen: (b) and (d) - the spiro DNSP configurations (a) and (c) - after photoisomerization to the zwitterionic merocyanine configuration. Isomerization of the spiro state to the merocyanine state and *vice versa* was induced by light.
- Fig. 28 illustrates the manner of modifying the protein Concanavalin A by linking thereto a photoisomerizable group.
- Fig. 29 depicts the change in response following challenge of an electrode with immobilized DNSP with an anti-DNP-antibody ( $\Delta I^{(1)}_{pc}$ ) versus the change in electrical response following further challenge of the electrode which an anti-antibody against anti-DNP-antibody.
- Fig. 30 illustrates the procedure of modification of an indium tin oxide (ITO) electrode, which is a transparent glass

electrode, by immobilizing thereon a linking group being 3-amino propyltriethoxysaline.

**[0055]** The invention will now be illustrated by several specific embodiments.

**[0056]** Reference is first being made to Fig. 1 which is a schematic representation of an embodiment of the direct mode of the invention. The surface of an electrode 1 is covered by an immobilized layer of a complex comprising a linking group 2 covalently bound to a member of a recognition pair 3. The electrode may typically be made of or coated by gold but may also be made from or coated by other metals such as silver or platinum. The electrode may also be a non metallic electrode, e.g. an ITO electrode. The electrode is immersed in a liquid medium containing a buffer and a redox couple R<sup>+</sup>/R 4. Two other electrodes (not shown) are used, a counter electrode typically made of platinum wire or graphite and a reference electrode typically as Ag/AgCl electrodes. The system allows sensitive electrochemical detection of the analyte member 5 of the recognition pair. The electrode immobilized layer is challenged with the analyte member of the recognition pair 5 which binds to its counterpart member immobilized on the surface of the electrode to produce an electrical response. Binding of the analyte member insulates the electrode towards the redox molecules producing a decrease in the electrical response, e.g. cyclic voltammogram. The amount of binding of the analyte member depends on the concentration of the analyte in solution. By measuring the electrical response of the electrode immobilized layer to challenge by various concentrations of analyte for a specified period of time, a calibration curve is obtained which allows an accurate determination of the antibody in a known sample. Concentrations below the nanomolar range are readily detectable. Typical coverage of the electrode surface by the immobilized member where the recognition pair comprises an antigen-antibody is of the order of 10<sup>-12</sup> mole cm<sup>-2</sup>. Binding to 10% or more of the surface is detectable.

**[0057]** The method is also applicable for the analysis of other recognition pairs such as sugar-lectin, ligand-receptor, biotin-avidin, oligonucleotide-DNA, oligonucleotide-protein, oligonucleotide-cell and substrate-enzyme

**[0058]** The nature of the redox molecules will vary depending on the nature of the recognition pair and whether it is to be bound to a member of the pair. In the simplest system as in Fig. 1, the redox molecules are freely tumbling in solution and are capable of changing their redox state by accepting electrons from or donating electrons to the electrode. An example is ferricyanide/ferrocyanide or the compound having the formula shown in Fig. 18(11).

**[0059]** The linking group is a compound comprising a moiety that facilitates association with, attachment to or chemisorbed onto the electrode surface, typically a sulphur containing moiety for immobilization onto a metallic electrode or an alkoxysaline residue for immobilization onto an ITO electrode; a connecting group; and comprising a functional group which is capable of forming a covalent bond with a moiety of the immobilized member of a recognition pair. An example of a linking group is cystamine. Where members of recognition pairs may be directly immobilized, the linking group is optional.

**[0060]** Fig. 2 shows another embodiment of the direct mode of the invention in which the redox molecule is bound to the analyte. The electrode with the immobilized layer is challenged by a sample containing the analyte member of the recognition pair (step (1)) and subsequently by a solution containing the analyte modified by linking thereto a redox molecule R (step 2).

**[0061]** For testing, the electrode is challenged with the biological or other analyte sample containing an unknown concentration of the analyte, for a fixed time and then thereafter with a solution of the modified analyte. The amount of the modified analyte that binds to the electrode's immobilized layer depends on the amount of unmodified analyte binding. As more immobilized layer sites are occupied by unmodified analyte, less sites will be available to the modified analyte. The electrical response thus inversely correlates with the concentration of the analyte in the tested sample.

**[0062]** The system may be calibrated by challenging the electrode with different known concentrations of the analyte and subsequently with a fixed concentration of modified analyte and then measuring the electrical response.

**[0063]** Reference is now being made to Fig. 3. The embodiment shown schematically in this figure is very similar to that shown in Fig. 2 with the difference being that the electrode in this embodiment is challenged simultaneously with the sample containing an unknown analyte concentration and with the modified analyte. The resulting electrical response is qualitatively similar.

**[0064]** As will no doubt be appreciated, the embodiments shown above are interchangeable in that the analyte in one embodiment may be the immobilized member in another and *vice versa*. For example, in order to detect the presence of a certain antigen in a sample, the immobilized member may be an antibody specifically directed against this antigen, whereas in order to detect the presence of the antibody, the immobilized member will be the antigen. This is illustrated in Figs. 4 and 5 which are essentially identical to Figs. 2 and 3 with the roles of the analyte and immobilized member reversed.

**[0065]** Reference is now being made to Fig. 6 which is a schematic representation of another embodiment in accordance with the direct mode of the invention. This embodiment allows the regeneration of the electrode after performance of a measurement to allow reuse in a subsequent measurement. This feat is achieved in accordance with this embodiment, by modifying the immobilized member 11 by a group 12, which as shown in Fig. 6(c) has two isomerization states, A and B, and is capable of switching reversibly between the two states by exposure to light at energies

$h\nu_1$  (having a wavelength  $\lambda_1$ ) and of energy  $h\nu_2$  (having a wavelength  $\lambda_2$ ). The switching between the two isomerization states A and B causes a conformational change of the modified immobilized member which brings to a change in its affinity to binding to analyte 13: in state A, the modified immobilized member is capable of binding analyte 13 with a high affinity; in state B, the affinity of binding to the analyte becomes very low.

5 **[0066]** Figs. 6(a) and (b) are very similar, the difference being in that the role of the immobilized member 11 and ligand 13 of Fig. 6(a) have been reversed in that analyte 13 and immobilized member 11 of Fig. 6(a) are immobilized member 11' and analyte 13', respectively. Apart from that the embodiments are identical and accordingly the description below will relate only to Fig. 6(a), it being understood that it applies equally also to the embodiments shown in Fig. 6 (b), and thus the stages in the use cycles  $a_1, a_2, a_3, a_4$  and  $a_5$  correspond to stages  $b_1, b_2, b_3, b_4$  and  $b_5$ , respectively  
10 of Fig. 6(b).

**[0067]** In the initial stage  $a_1$ , group 12 is in an isomerization state A where it has high affinity of binding to analyte 13. In the presence of analyte 13, the analyte binds to the immobilized member, stage  $a_1$ , which binding gives rise to a change in the electrochemical response,  $a_3$ . After performance of the measurement, the electrode is illuminated by a light of a wavelength  $\lambda_1$ , and consequently group 12 assumes its isomerization state B and consequently there results  
15 a conformational change of immobilized member 11 giving rise to a low affinity of binding to analyte 13. Consequently, as in stage  $a_4$ , the analyte 13 dissociates from immobilized member 11. The system is then rinsed to remove the unbound analyte, and after removal, stage  $a_5$ , the electrode is illuminated with light of a wave-length  $\lambda_2$ , and consequently group 12 is isomerized back to its state A and the modified immobilized member assumes its original conformation,  $a_1$ . At this stage  $a_1$ , the electrode is ready for reuse.

20 **[0068]** It will be appreciated that similarly as in the embodiment of Fig. 5, also in the embodiment of Fig. 6, use can also be made with a modified analyte shown in Figs. 2 and 3.

**[0069]** Reference is now being made to Fig. 7 showing an embodiment in accordance with the indirect mode of the invention. In this embodiment, a system comprising an electrode 21 with a layer of immobilized members 22 is used for determination of an agent 23 in a biological sample 24, which agent is identical (albeit not immobilized) to the  
25 immobilized member. In accordance with this embodiment, a solution 25 comprising a known concentration of an analyte 26 is reacted with sample 24. Following this reaction there is binding between analyte molecules 26 and agent molecules 23, the degree of binding depending on the agent's concentration. The electrode is then challenged with the reacted solution 27 following which there is binding of free analyte molecules to the immobilized member, the degree of binding depending on the amount of free analyte molecules in solution 27. The change in the electrical response allows determination of the concentration of the free analyte 26 in solution 27 which in turn serves determination  
30 of the agent 23 in sample 24.

**[0070]** Reference is now being made to Fig. 8 showing another embodiment in accordance with the indirect mode of the invention. The embodiment of Fig. 8 is in essence similar to that of Fig. 7 with the difference being that immobilized member 22' is not identical to agent 23' to be determined in sample 24' but rather has only similar binding characteristics to analyte 26'.  
35

**[0071]** Reference is now being made to Fig. 9 showing a further embodiment in accordance with the indirect mode of the invention. This embodiment allows determination of an enzyme 31 which as shown in Fig. 9(a) catalyzes a reaction in which an analyte 32 is broken down to products 33 and 34.

40 **[0072]** As shown in Fig. 9(b), a solution 35 containing a known concentration of analyte 32 is reacted with a biological sample 36 containing an unknown concentration of enzyme 31, which is the agent to be determined in this biological sample. Following this reaction, some of the analyte 32 is degraded by the enzyme to reaction product 33, the degree of degradation depending on the concentration of enzyme 31 in sample 36. Electrode 37, carrying a layer of immobilized members 38 is then reacted with reacted solution 39, whereupon free analytes 32 bind to the immobilized members 38 on the electrode. The change in the electrical response allows the determination of the analyte in solution 39 which  
45 in turn allows the determination of enzyme 31 in sample 36.

**[0073]** Reference is now being made to Fig. 10 which is similar to the embodiment of Fig. 9 and accordingly like components have been given like numbers with a prime indication. In this embodiment, enzyme 31' bring to reaction in which precursor analyte molecules 33' and 34' are catabolized to yield analyte molecule 32'. In this embodiment as shown in Fig. 10(b), a solution 35' containing a known concentration of precursor analyte 33' is reacted with a sample  
50 36' containing an unknown amount of enzyme 31'. Electrode 37' having immobilized thereon a layer of member 38', is then challenged with reacted solution 39', whereupon analyte molecules 32' bind to the immobilized member 38', the degree of binding depending on the level of analyte molecules in-solution 39'. By determining a change in the electrical response, the concentration of analyte 32' in solution 39' is determined, which allows in turn determination of enzyme 31' in sample 36'.

55 **[0074]** Reference is now being made to Fig. 11 illustrating a still further embodiment of the indirect mode of the invention. In this embodiment, an unknown amount of an enzyme 41, which catabolizes a reaction similar to that of enzyme 31' in the embodiment of Fig. 10, is added to sample 42 which contains an unknown amount of biological agent 43 to be determined. This agent is in fact a precursor analyte which is converted by enzyme 41 to analyte 44.

Following the reaction, electrode 45 having immobilized thereon a layer of an immobilized member 46 is reacted with solution 55 following which there is binding of analyte molecules 44 to the immobilized member 46, the degree of binding being dependent on the concentration of analyte 44 in solution 55. The change in the electrical response which is determined, serves then as a measure for the determination of the concentration of analyte 44 in solution 55, which in turn serves to determine the concentration of agent 43 in biological sample 42.

[0075] Reference is now being made to Fig. 12 showing an embodiment in accordance with the invention in which the change in electrical response of the electrode resulting from binding of the analyte to the bound member is amplified by the use of agents which bind to the bound analyte. In Fig. 13(a) there is seen an electrode 51 carrying an immobilized member 52, which in this case is an antigen which binds specifically to an antibody 53. A cyclic voltammogram of this electrode yields a control response 54. When the electrode is challenged with a solution comprising antibody 53, there is binding of the antibodies to the electrode as seen in Fig. 13(b). Cyclic voltammogram 54' shows a decrease in the electric response. Where, however, there is only a minute quantity of antibody 53 in the tested sample, the change in this response relative to control 54 is small:

[0076] In order to amplify the change in electrical response, the electrode is then challenged with a solution comprising an anti-antibody 55 which binds specifically to antibody 53. As a result, there is the formation of a molecular complex 56 on the bound antibody which hinders further the access of the redox couple  $R^+/R$  to the surface of the electro material of the electrode and consequently, a cyclic voltammogram 54'' shows a marked decrease when compared to the control 54.

[0077] The invention will now be illustrated further by the Examples below.

#### Example 1: Antigen-Antibody Recognition Pair (direct mode)

##### Determination of the anti-DNP-antibody by an electrode with an immobilized layer comprising DNP

[0078] The manner of construction of the electrode used in this example is shown in Fig. 13. A polished gold electrode (area  $3 \times 10^{-2} \text{ cm}^2$ ) was immersed in a solution of 3,3'-dithiodipropionic acid bis(N-hydroxy-succinimide ester) 0.1 M in dry DMF, for 2 hours. The electrode was washed with dry DMF and then immersed in 0.025 M solution of Nε-2,4-DNP-lysine in DMSO:THF (1:1) and 15 μL (per 5 cc) diethylpropyl amine overnight at room temperature.

[0079] The electrochemical experiments were performed in a three electrode cell using the Nε-2,4-DNP-lysine antigen monolayer electrode as a working electrode, a Pt-wire as a counter electrode and Ag/AgCl as the reference electrode. The electrolyte was composed of 1.1 mM  $K_4Fe(CN)_6$  being the redox molecule, and 0.15 M NaCl in phosphate buffer solution (0.01 M, pH = 7.4). The temperature was  $37 \pm 2^\circ\text{C}$  and the scan rate was 200 mV/sec. The electrode was immersed for 15 min. in a solution of antibody anti-DNP. The amperometric responses of the  $K_4Fe(CN)_6$  (the redox probe) at different antibody anti-DNP concentrations were recorded.

[0080] The cyclic voltammograms without anti-DNP antibody (control - curved marked a) and with increasing concentrations of anti-DNP antibody (curves marked b-e), are shown in Fig. 14(a). As can be seen, there is a decrease in the electrical response as a function of antibody concentration. Fig. 14(b) shows the change in the current response at the peak versus control ( $\Delta I_{pc}$ ) as a function of the antibody concentration. As can be seen, the change in the amperometric response is a linear function of the antibody concentration. As can be seen further, antibody concentrations as low as 0.5 μM can be detected.

#### Example 2: Antigen-Antibody Recognition Pair (direct mode)

##### Determination of anti-fluorescein-antibody by an electrode with an immobilized fluorescein layer

[0081] The manner of preparation of an electrode used in this Example is shown in Fig. 15. A polished gold electrode (area  $3 \cdot 10^{-2} \text{ cm}^2$ ) was immersed in a solution of 3,3'-dithiodipropionic acid bis(N-hydroxy-succinimide ester) 0.02 M in DMSO for 2 hours. The electrode was washed with DMSO and with THF and then immersed in a solution that contains 1,12-diaminododecane, 25 mg in 2.5 ml THF for 24 hours at room temperature.

[0082] The modified electrode was immersed for another 24 hours at room temperature in a solution of 20 mg fluorescein isothiocyanate solubilized in 300 μl of dry DMF.

[0083] The electrochemical experiments were performed in a three electrode cell using the fluorescein antigen monolayer electrode as the working electrode, a Pt-wire as a counter electrode and Ag/AgCl as the reference electrode. The electrolyte was composed of 1.1 mM  $K_4Fe(CN)_6$ , being the redox molecule and 0.15 M NaCl in phosphate buffer solution (0.01 M, pH = 7.4). The temperature was  $37 \pm 1^\circ\text{C}$  and the scan rate was 200 mv/sec.

[0084] Fig. 16 shows the amperometric response of the fluorescein electrode as a function of anti-fluorescein antibody concentration. The amperometric response was measured after 1 min. of incubation of the electrode in the antibody solution. As can be seen there is a linear dependency between the antibody concentration and the change in the

amperometric response.

### Example 3: Antigen-Antibody Recognition Pair (direct mode)

#### 5 Determination of an anti-peptidic antibody by the use of an electrode with an immobilized peptidic layer

[0085] An antigen peptide shown in Fig. 17(a) was synthesized by the F-MOC solid phase peptide synthesis method using protected Cys, Asp, Tyr, Lys side chains that are acid labile but stable under basic (piperidine) conditions, used for F-MOC removal (G.G. Fields et al., *Int. J. Peptide Protein Res.*, **33**, 1989, 298-303). The crude peptide was purified by HPLC (RP-18).

[0086] An immobilized layer antigen electrode, shown schematically in Fig. 17(b) was prepared by immersing a polished gold electrode (area  $3 \times 10^{-2} \text{ cm}^2$ ) into 300  $\mu\text{l}$  of 0.1M peptide solution of (2:1)  $\text{H}_2\text{O}:\text{CH}_3\text{CN}$ , 0.1% TFA,  $\text{pH}=1$ , for a period of three hours.

[0087] Electrochemical measurements were performed in a three-electrode cell using the modified electrode (Fig. 17(b)) as working electrode, a Pt wire as counter electrode, and Ag/AgCl as reference electrode. The electrolyte compositions were 1.0 mM  $\text{K}_4\text{Fe}(\text{CN})_6$ , 0.15 M  $\text{CaCl}_2$  in phosphate buffer solution 0.01 M, ( $\text{pH}=7$ ). The temperature was  $20 \pm 1^\circ\text{C}$  and the scan rate was 200 mV/sec. The redox molecules ferricyanide/ferrocyanide accept electrons from or donate them to the electrode and their increasing insulation from the electrode functions as a measure to determine the association of the antibody to the antigen immobilized layer electrode. Fig. 18 shows the cyclic voltammograms of the electrical response of the antigen immobilized layer electrode in the presence of the redox molecule. Upon addition of the antibody at a concentration of 0.23  $\mu\text{g}/\text{ml}$ , a gradual decrease in the electrochemical response is seen (curves b to d). After 35 minutes (in curve d) the cathodic decrease corresponds to 55% of its original value in the absence of antibody.

#### 25 Example 4: Sugar-Lectin Recognition Pair (direct mode)

#### Determination of Concanavalin A (Con A) by the use of an electrode having an immobilized sugar layer

[0088] The protein Con A is a lectin which binds specifically to the monosaccharide  $\alpha\text{-D-Mannopyranose}$ . Con. A was modified by linking to it the redox molecule N-methyl-N'-carboxymethylene-4,4'-bipyridinium having the formula (11) in Fig. 19.

[0089] The chemical attachment of N-methyl-N'-carboxymethylene-4,4'-bipyridinium to Con A was performed by means of carbodiimide coupling of the carboxy group to amino group of the lysine residues of the protein molecule. 23 mg of N-methyl-N'-carboxymethylene-4,4'-bipyridinium, 80 mg HEPES and 184 mg of urea were solubilized in 1.6 ml of distilled water, the pH of the solution was adjusted to 7.2 and then cooled to  $4^\circ\text{C}$ . 50 mg. of Con. A in 1 ml aqueous solution ( $4^\circ\text{C}$ ) was added to the solution and then 5.5 mg of N-hydroxy-sulfosuccinimide sodium salt (sulfo-NHS) and 12 mg 1-ethyl-3-(3-dimethylaminopropyl)carbodiimide (EDC) as coupling reagents were added. The resulting mixture was allowed to react overnight ( $4^\circ\text{C}$ ). The resulting solution was dialyzed against phosphate buffer  $\text{pH}=7$  (0.0875 M,  $\text{MnCl}_2$  0.1 mM,  $\text{CaCl}_2$  0.1 mM,  $\text{NaCl}$  0.15 M) and then against distilled water. The dialyzed solution was centrifuged (30 min,  $4^\circ\text{C}$ , 15000 rpm), and the supernatant was lyophilized to obtain a powder of the chemically modified Con. A (30 mg). The loading of concanavalin A by N-methyl-N'-carboxymethylene-4,4'-bipyridinium corresponds to 3 bipyridinium groups per protein molecule.

[0090] The monosaccharide immobilized layer associated with the Au electrode was prepared by the sequence of transformations illustrated in Fig. 20. A polished gold electrode (area  $\sim 3 \times 10^{-2} \text{ cm}^2$ ) was treated with 0.02 M aqueous solution of cystamine for two hours. The resulting cystamine modified electrode was then reacted with the functionalized monosaccharide, p-isothiocyanatophenyl  $\alpha\text{-D-mannopyranoside}$  (formula (12) in Fig. 21) by immersing the electrode immobilized layer in a solution of 1 mg of p-isothiocyanatophenyl  $\alpha\text{-D-mannopyranoside}$  in 300  $\mu\text{l}$  of phosphate buffer 0.1 M,  $\text{pH}=7.3$ , to yield the thiourea-linked monosaccharide immobilized layer electrode.

[0091] The electrochemical experiments were performed in a three electrode cell using the monosaccharide immobilized layer electrode as working electrode, a Pt-wire as counter electrode, and Ag/AgCl as reference electrode. The electrolyte was 1 mM KCl in phosphate buffer, 0.1 M ( $\text{pH}=8$ ), the temperature was  $20 \pm 1^\circ\text{C}$ , and the scan rate was 1000 mV/sec.

[0092] Different concentrations of Con. A and a constant concentration of Con. A modified by linking to it redox molecules (modified Con A) were introduced into the cell. The systems were allowed to equilibrate for 2 hours and the cyclic voltammograms were recorded.

[0093] Fig. 21 shows the electrochemical responses of the system at different Con. A concentrations and constant concentration of modified Con. A (25  $\mu\text{M}$ ). Curve (a) is the electrochemical response when the concentration of Con. A is 0 M and the cathodic current is high, and where the concentrations of Con. A are (b) 2.5  $\mu\text{M}$ ; (c) 5  $\mu\text{M}$ ; (d) 10  $\mu\text{M}$ ,

(e) 20  $\mu$ M. As the concentration of Concanavalin A increases, the cathodic current decreases.

[0094] Fig. 22 shows the calibration curve of the charge involved with the reduction of modified Con. A vs. the concentration of unmodified Con. A. This change represents the integrated areas of the reduction or oxidation curves of the voltammograms shown in Fig. 23. By using this calibration curve unknown concentrations of Con. A can be determined down to a level of  $1 \times 10^{-6}$  M.

[0095] Fig. 23 shows the cathodic current involved at the reduction of the modified Con. A as a function of unmodified Concanavalin A.

#### Example 5: Sugar Lectin Recognition Pair (Indirect mode)

##### Determination of Con A by the use of an electrode having an immobilized sugar layer

[0096] A polished gold electrode (area  $3 \times 10^{-2}$  cm<sup>2</sup>) was immersed in an aqueous solution of 0.02M cystamine for 2 hours. The electrode was washed with H<sub>2</sub>O then immersed in a solution of 1.5 mg  $\alpha$ -D-mannopyranosylphenylisothiocyanate solubilized in 0.125 ml DMSO and 0.95 ml 0.1 M potassium phosphate buffer, pH = 7, at room temperature.

[0097] A solution composed of 1 potassium phosphate buffer, pH = 7.8, 1 mM KCl, 0.1 mM MnCl<sub>2</sub>, 0.1 mM CaCl<sub>2</sub>,  $1 \times 10^{-7}$  M Con. A was mixed with a solution composed of  $1 \times 10^{-4}$  M,  $1 \times 10^{-5}$  M,  $1 \times 10^{-6}$  M,  $1 \times 10^{-7}$  M, and  $1 \times 10^{-8}$  M of  $\alpha$ -D-mannopyranoside. The mixture was incubated for 30 min. at room temperature and a modified electrode was then immersed in this mixture for 6 min. The electrodes were then washed with the same buffer as above and used for electrochemical measurements.

[0098] The electrochemical experiments were performed in a three electrode cell using the mannopyranoside monolayer electrode as the working electrode, a Pt-wire as a counter electrode and Ag/AgCl as the reference electrode. The electrolyse was composed of 1 mM K<sub>4</sub>Fe(CN)<sub>6</sub> being the redox probing molecule and 1 mM KCl in phosphate buffer solution (0.1 M, pH = 7.8). The scan rate was 200 mV/s.

[0099] Fig. 24 shows the amperometric responses of electrodes with an immobilized mannose layer upon interaction with the above Con A solutions that include different concentrations of  $\alpha$ -D-mannopyranoside. This curve may serve as a calibration curve for analysis of mannose in an unknown sample by such electrodes.

#### Example 6: Reversible binding of Antigen-Antibody Recognition Pair (direct mode)

##### Determination of an anti-DNP antibody by an electrode with an immobilized dinitrospiropyran (DNSP) pair

[0100] The affinity of anti-DNP is high towards the isomer dinitrospiropyran (formula 13(a) in Fig. 19) but low towards the isomer dinitromerocyanine (formula 13(b) in Fig. 19).

[0101] The dinitro spiropyran compound and its derivatives exhibit reversible photoisomerizable properties. Illumination of dinitrospiropyran (formula 13(a)) in a wavelength between 300 nm and 400 nm, isomerizes this compound to dinitromerocyanine (formula 13(b)) while irradiation of dinitromerocyanine in the visible spectral region of more than 480 nm results in isomerization to yield dinitrospiropyran.

[0102] An electrode with an immobilized layer of dinitrospiropyran (DNSP) was constructed according to the Scheme illustrated in Fig. 24. A polished gold electrode (area  $3 \times 10^{-2}$  cm<sup>2</sup>) was immersed in a 0.2 M cystamine dihydrochloride aqueous solution for two hours. The cystamine modified electrode was washed with dry DMF and then immersed into 0.2 M of the spiropyran functionalized active ester having the formula 14(a) in Figs. 19 and 25 in dry DMF solution. The resulting electrode was rinsed with distilled water.

[0103] The DNSP antigen immobilized layer electrode was examined both as an electrical immunosensor for anti-DNP-antibody and for reversible detachment of the antibody. The DNSP electrode in its first state ((a) in Fig. 25) was challenged by anti-DNP-antibody so as to form antigen-antibody pair complexes and then treated for reuse by consecutive irradiation at between 400 nm and 300 nm for conversion of the antigen to its second state ((b) in Fig. 25) and release of antibody and subsequent irradiation at above 480 nm (or thermal treatment) to restore the immobilized antigen layer to its first, active state.

[0104] The electrochemical measurements were performed in a three electrode cell using the DNSP antigen immobilized layer electrode as working electrode, a Pt-wire as counter electrode and Ag/AgCl electrode as reference electrode. The electrolyte was composed of 1 mM K<sub>4</sub>Fe(CN)<sub>6</sub>, 0.15 M NaCl, in phosphate buffer solution (0.01 M, pH=7.4) and 8  $\mu$ M of anti-DNP, the temperature was  $37 \pm 1^\circ$ C and the scan rate was 200 mV/sec.

[0105] Reference is now being made to Fig. 26 showing cyclic voltammograms of the DNSP electrode after 16 mins (curve (c) is at time t=0, curve z is at time t=16 mins.) incubation of the electrode with anti-DNP antibody. Fig. 26(a) shows results with an electrode wherein the antigen is in its original state (state (a) in Fig. 25), while Fig. 25(b) is an electrode in which the antigen was photoisomerized to the zwitterionic merocyanine configuration (state (b) in Fig. 25). The results clearly indicate that the antibody, which binds to the DNSP, insulates the electrode and decreases the

electrical response. In comparison, the antibody does not actually bind to the inactive merocyanine isomer as is evident from the fact that the voltammogram remains almost unchanged as compared to the initial electrode response (curve c).

[0106] Reference is now being made to Fig. 27 showing the change in the amperometric response, versus control, at various electrode states. In each state, the electrode was incubated for 16 mins. with anti-DNP antibody. In this experiment the electrode was initially in a state wherein the immobilized antigen had the zwitterion merocyanine configuration (configuration (b) in Fig. 25). Following incubation with anti-DNA antibody, there is a high amperometric response (full dot, marked a) implying that the antibody does not actively interact with the immobilized antigen layer. Irradiation of the electrode at a wavelength above 480 nm, results in isomerization of the antigen to the spiropyran configuration (configuration (a) in Fig. 25). Incubation of this electrode with anti-DNP antibody for 16 mins. results in a decrease in the amperometric response of the electrode (empty square marked b) demonstrating the association of the antibody to the electrodes and its subsequent insulation. Further illumination at a wavelength between 300-400  $\mu\text{m}$  results in conversion of the antigen layer back to the merocyanine configuration and in this state the electrode is again inactive towards anti-DNP antibody (full dot marked c): the high amperometric response of the resulting electrode implies that release of the antibody from the electrode surface has taken place. Further irradiation of the electrode at more than 480 nm converts the antigen back to the spiropyran configuration and the electrode can at this state again bind anti-DNP antibody (empty square marked d). Such an electrode can thus be used for repeated measurements.

#### Example 7: Antigen-Antibody Recognition Pair (indirect mode)

20 **Determination of N $\epsilon$ -2,4-DNP-Lysine by reaction with anti-DNP antibody and by the use of an electrode with an immobilized DNP layer**

[0107] The electrode preparation was carried out as described in Example 6, and illustrated in Fig. 25.

[0108] The agent solution was composed of 0.15 M NaCl in phosphate buffer (0.01 M, pH = 7.4) and different concentrations of the antigen N $\epsilon$ -2,4-DNP-lysine (having the formula 19 in Fig 19). The analyte, anti-DNP-antibody (50  $\mu\text{M}$ ) was added to the agent solutions and mixed for 5 min. at  $37 \pm 2^\circ\text{C}$ .

[0109] The electrodes were illuminated with light,  $\lambda > 450 \text{ nm}$ , to ensure that the immobilized antigen monolayer will have the configuration (a) in Fig. 24. The electrode was then incubated in the antigen solutions for 18 min, washed with distilled water and used for electrochemical measurements.

[0110] The electrochemical measurements were performed in a three-electrode cell using the DNP-monolayer electrodes after treatment in the analyte solution, as the working electrodes, a Pt-wire as a counter electrode and Ag/AgCl as a reference electrode. The electrolyte was composed of 1.1 mM  $\text{K}_4\text{Fe}(\text{CN})_6$  being the redox molecule, and 0.15 M NaCl in phosphate buffer solution (0.01 M, pH = 7.4). The temperature was  $37 \pm 2^\circ\text{C}$ , the scan rate was 200 mV/sec.

[0111] Fig. 27 shows the calibration curve of the electrode responses at different agent concentrations in the agent solution.  $\Delta I_{pc}$  is the difference between the amperometric response of the antigen electrode in the presence of the redox probe only, and the response of the electrode after the treatment described above, with variable antigen concentrations.

#### Example 8:

40 **Method for the modification of proteins by a group reactive to exposure to light energy.**

[0112] The modification of the proteins by a group reactive to exposure to light energy was performed for example by carbodiimide coupling of the respective photoisomerizable active ester groups with the amino group of lysine residues which are a part of the protein molecule. The proteins that were modified by this method were Concanavalin A (Con. A), papain and chymotrypsin. The respective photoisomerizable active esters are N-hydroxysuccinimide ester of N-propionic acid spiropyran (formula 14(a) and 15), N-hydroxysuccinimide ester of 4-carboxy azobenzene (16) and N-hydroxysuccinimide ester of thiophenfulgide (17) (the formulae are illustrated in Fig. 19).

[0113] The modification process was carried out by reacting 50 mg of the protein in 6 ml of an aqueous solution that contained 250 mg  $\text{NaHCO}_3$  with 5-15 mg (according to the loading that is required) of the active ester dissolved in 200  $\mu\text{L}$  of THF at  $0^\circ\text{C}$  for 24-48 hours.

[0114] Fig. 28 shows an example of modification of Con A by linking to it a photoisomerizable compound. The active ester N-hydroxysuccinimide ester of thiophenfulgide (formula 17) was reacted with Con A and the resultant solution was centrifuged (15000 rpm, 30 min,  $4^\circ\text{C}$ ). The supernatant was then lyophilized to obtain a powder of modified protein.

55 The loading degree was determined by conventional methods including absorbance measurements of the chromophore associated with the modified protein ( $\epsilon$  2200  $\text{cm}^{-1}$ ,  $\lambda = 532 \text{ nm}$ ) and determination of total protein content in the respective samples by the Lowry method (Lowry, O.H. *et al.*, *J. Biol. Chem.* **103**, 265 (1951)).

[0115] All modified proteins were capable of being converted from a first state to a second state and from the second



state to the first in a substantially reversible manner and the states were followed spectroscopically.

#### Example 9: Increasing Sensitivity

##### 5 Increasing the sensitivity of anti-DNP-antibody analysis using an anti-IgE antibody

[0116] An electrode with an immobilized layer of dinitrospiropyran (DNSP) was prepared by the method detailed in Example 6 and illustrated in Fig. 25. The DNSP electrode was challenged with a solution comprising 100  $\mu$ M anti-DNP-antibody, for various periods of time, in which antigen-antibody pair complexes formed on the surface of the electrode. (The longer the time of incubation the higher is the amount of complex formation). The different electrodes were then electrochemically analyzed in the electrochemical cell described in Example 6. The amperometric response of the electrodes was recorded.

[0117] The electrodes were then incubated at 37°C in a PBS buffer solution that contained 2.5 mg/ml of an anti-mouse IgE antibody for 10 mins. (The anti-DNP-antibody is a mouse IgE and the anti-mouse IgE thus forms a complex on the anti-DNP-antibody bound on the surface of the electrode). The electrodes were then transferred to the electrochemical cell as detailed in Example 6 and the amperometric response of the electrodes was recorded.

[0118] Reference is now being made to Fig. 1 in which  $\Delta i^{(1)}_{pc}$  represents the change in the amperometric response of the electrode after it was challenged with the anti-DNP-antibody (as compared to the response prior to this challenge) and  $\Delta i^{(2)}_{pc}$  represents the change in the amperometric response after the second challenge with the anti mouse IgE antibody. As can be seen in this figure, the values of  $\Delta i^{(1)}_{pc}$  (X-axis) and the value of  $\Delta i^{(2)}_{pc}$  (Y-axis) show a linear interrelation. The slope of this plot represents the enhancement factor of the electrode sensitivity following a challenge with the anti-IgE antibody. In this case the sensitivity was enhanced by a factor of about 2.3.

##### 25 Example 10: Use of an Electrode other than Gold.

[0119] An electrode made of indium tin oxide (ITO) glass, is modified by incubating the electrode with a 1% (v/v) 3-amino propyltriethoxysilane with an organic solvent such as acetone, toluene or benzene. Following incubation, this linking group is immobilized on the electrode. Various antigens and proteins can then be immobilized through the amino residue of this linking group.

#### Claims

1. An electrobiochemical system for the determination of the presence and optionally concentration of an analyte in a liquid medium, the analyte being one member of a recognition pair, the system comprising:

(i) an electrode having immobilized thereon the other member of a recognition pair, being immobilized on the surface of the electrode by means of a linking group, such that the presence of said analyte in the medium results in formation of pair complexes on the electrode, wherein the immobilized member of the recognition pair has or is linked to a group reactive to exposure to light energy: said group having a first and a second state and is capable of being converted from the first state to the second state by exposure to irradiation of light of a first wavelength and from the second to the first state by exposure to irradiation of light of a second wavelength; the exposure inducing a conformational change in the binding site of the immobilized member resulting in a change in affinity of the immobilized member for binding to said analyte, whereby in the first state said immobilized member has a high affinity of binding to said analyte such that the analyte remains essentially bound to the immobilized member and in said second state said immobilized member has a low affinity of binding to said analyte, such that the bound analyte is readily dissociated; and

(ii) redox molecules which can change their redox state by accepting electrons from or donating electrons to the electrode;

formation of a pair complex on the electrode brings to a change in the electrical response of the system, whereby the presence and optionally concentration of said analyte in the medium can be determined.

2. The system according to claim 1, wherein the linking group has the following general formula (I):

wherein:

5

Z in case where the electrode material is a metal, represents a sulphur-containing moiety which is capable of chemical association with, attachment to or chemisorption onto said metal; and in case where the electrode material is glass, represents methoxy or alkoxy silane residues which are capable of chemical association, attachment to or chemisorption onto said glass;

10

R<sup>1</sup> represents a connecting group;

Q is a functional group which is capable of forming a covalent bond with a moiety being a member of a recognition pair.

15

3. The system according to claim 1 or 2, for use in the determination of an analyte being one of a recognition pair, the pair being selected from the group consisting of antigen-antibody, sugar-lectin, ligand-receptor, biotin-avidin, enzyme-substrate, oligonucleotide-DNA, oligonucleotide-protein, oligonucleotide-cell and substrate-enzyme, the immobilized member on the electrode being the other one of said pair.

20

4. The system according to any one of claims 1 to 3, for the determination of an agent in a biological sample, wherein said agent is different than said analyte, said change in the electrical response as a result of the formation of said pair complex serves for an indirect determination of said agent in the sample.

25

5. The system according to any one of claims 1 to 4, wherein said redox molecule is freely tumbling in solution.

6. The system according to any one of claims 1 to 4, wherein said redox molecule is linked to an analyte molecule.

7. The system according to any one of claims 1 to 6, wherein the electrode material is gold, platinum or silver.

30

8. The system according to any one of claims 1 to 6, wherein the electrode material is a conducting glass.

9. A method for the determination of the presence and optionally the concentration of an analyte in a liquid medium, comprising:

35

(a) contacting an electrode having immobilized thereon a member of a recognition pair, being immobilized on the surface of the electrode by means of a linking group, the other member of said pair being said analyte with a medium comprising the analyte to be determined and with a redox molecule capable of changing its redox state by accepting electrons from or donating electrons to the electrode, wherein the immobilized member of the recognition pair has or is linked to a group reactive to exposure to light energy, said group having a first and a second state and is capable of being converted from the first state to the second state by exposure to irradiation of light of a first wavelength and from the second to the first state by exposure to irradiation of light of a second wavelength; the exposure inducing a conformational change in the binding site of the immobilized member resulting in a change in affinity of the immobilized member for binding to said analyte, whereby in the first state said immobilized member has a high affinity of binding to said analyte such that the analyte remains essentially bound to the immobilized member and in said second state said immobilized member has a low affinity of binding to said analyte, such that the bound analyte is readily dissociated;

40

45

(b) contacting said electrode with said medium and measuring said electric response;

50

(c) irradiating said electrode by light having a first wavelength;

(d) measuring the change in electric response as a result of contact with said solution, whereby the presence and optionally the concentration of said analyte can be determined;

55

(e) rinsing the electrode so as to remove analyte molecules from the medium surrounding the electrode; and

(f) irradiating said electrode by light having a second wavelength whereby the electrode is ready for re-use.

- 5 10. The method according to claim 9, for the determination of analyte being one of a recognition pair of the group of pairs consisting of antigen-antibody, sugar-lectin, ligand-receptor, biotin-avidin, enzyme-substrate, oligonucleotide-DNA, oligonucleotide-protein, oligonucleotide-cell and substrate-enzyme; wherein said immobilized member is the other one of said pair.
- 10 11. The method according to claim 9 or 10, for the determination of an agent in a sample, said agent being said analyte and the method comprises contacting the electrode with said sample or a fraction thereof containing said agent.
- 15 12. The method according to claim 9 or 11, for the determination of an agent in a sample, the agent being a molecule other than said analyte, contact of a solution comprising said agent with a reagent solution bringing either to the formation of said analyte in the reagent solution or to reduction in free analyte concentration in said reagent solution; the method comprising:
- (a) reacting said sample or a fraction thereof comprising said agent with said reagent solution;
- (b) contacting the electrode with the product of the reaction of (a);
- 20 (c) measuring the change in electrical response resulting from contact of the electrode with said reaction product, whereby the presence and optionally concentration of said agent in said sample is determined.
- 25 13. The method according to claim 12, wherein said analyte is a molecule which binds to said agent.
14. The method according to claim 13, wherein said agent has the same binding characteristic to said analyte as the immobilized member.
- 30 15. The method according to claim 12, wherein said agent is a molecule which is either
- (i) broken down by an enzyme into products, one of them being said agent;
- (ii) being a precursor molecule which is converted by an enzyme to said agent;
- said reagent solution comprising said enzyme.
- 35 16. The method according to any one of claims 9 to 15, wherein the redox molecule is freely tumbling in the solution.
- 40 17. The method according to any one of claims 9 to 15, wherein the redox molecule forms part of a modified analyte comprising an analyte molecule linked to a redox molecule.
18. The method according to claim 17, wherein the electrode is contacted simultaneously with the medium in which the analyte is to be determined and with said modified analyte.
- 45 19. The method according to claim 17, wherein the electrode is first contacted with the medium in which the analyte is to be determined and subsequently with said modified analyte.
20. The method according to any one of claims 9 to 19, wherein the analyte molecules are conjugated or complexed with a large molecule or a group of molecules, whereby the method's sensitivity is increased.
- 50 21. A substantially reusable electrode for use in the electrobiochemical system according to any one of claims 1 to 8, for the determination of the presence and optionally concentration of an analyte in a liquid medium, the electrode comprising an electrode material capable of electrical communication with a redox molecule: there being immobilized on the electrode material a layer of a member of a recognition pair, being immobilized on the surface of the electrode by means of a linking group, the other member of the pair being said analyte; the electrical communication between the redox molecule and the electrode material being modified by binding of said member to said analyte;
- 55 the immobilized member has or is linked to a group reactive to exposure to light energy, said group having a first and a second state and is capable of being converted from the first state to the second state by exposure to irradiation of light of a first wavelength and from the second to the first state by exposure to irradiation of light of

a second wavelength; the exposure inducing a conformational change in the binding site of the immobilized member resulting in a change in affinity of the immobilized member or binding to said analyte, whereby in the first state said immobilized member has a high affinity of binding to said agent such that the bound analyte is not readily dissociated and in said second state said immobilized member has a low affinity of binding to said analyte, such that the bound agent is readily dissociated and can be removed from the system and the electrode can then be exposed to light of a second wavelength inducing a change to said first state, whereby the electrode will be ready for re-use, whereby the presence and optionally the concentration of said analyte in a medium surrounding the electrode can again be determined.

22. The electrode according to claim 21, wherein the linking group has the following general formula (I):



wherein:

Z in case where the electrode material is a metal, represents a sulphur-containing moiety which is capable of chemical association with, attachment to or chemisorption onto said metal; and in case where the electrode material is glass, represents methoxy or alkoxy silane residues which are capable of chemical association, attachment to or chemisorption onto said glass;

R<sup>1</sup> represents a connecting group;

Q is a functional group which is capable of forming a covalent bond with a moiety being a member of a recognition pair.

23. The electrode according to claim 21 or 22, wherein said group reactive to exposure to light energy is selected from the group consisting of azobenzenes, spiropyranes, fulgides, thiophenefulgides and malachite green.

24. A process for preparing an electrode according to claim 22 or 23, comprising:

(a) immobilizing said linking group onto the electrode material by chemical association attachment or chemisorption of the sulphur-containing moiety or functionalized alkoxy silane to the metal or glass electrode material, respectively;

(b) chemically modifying a member of said recognition pair with a photoisomerizable group whereby the modified member changes its bonding affinity to the other member of the recognition pair by exposure to light energy; and

(c) binding the modified member of the recognition pair to said functional group of the linking group immobilized on the electrode.

25. A process for preparing an electrode according to claim 22 or 23, comprising:

(a) immobilizing said linking group onto the electrode material by chemical association attachment or chemisorption of the sulphur-containing moiety or functionalized alkoxy silane to the metal or glass electrode material respectively;

(b) binding a member of the recognition pair to said functional group of the linking group immobilized on the electrode; and

(c) chemically modifying said member of the recognition pair with a photoisomerizable group whereby the modified member changes its bonding affinity to the other member of the recognition pair by exposure to light energy.

26. The process according to claim 25, wherein step (b) precedes step (a).

## Patentansprüche

1. Elektrobiokemisches System zur Bestimmung des Vorhandenseins und gegebenenfalls der Konzentration eines Analyten in einem flüssigen Medium, der ein Element eines Erkennungspaares ist, wobei das System umfasst:

5

- (i) eine Elektrode, an der das andere Element eines Erkennungspaares auf der Oberfläche der Elektrode mittels einer verbindenden Gruppe so immobilisiert ist, dass das Vorhandensein des genannten Analyten in dem Medium zur Bildung von Paar-Komplexen auf der Elektrode führt, wobei das immobilisierte Element des Erkennungspaares aufweist oder gebunden ist an eine Gruppe, die reaktionsfähig ist bei Einwirkung von Lichtenergie; die genannte Gruppe einen ersten und einen zweiten Zustand aufweist und von dem ersten Zustand in den zweiten Zustand überführt werden kann durch Einwirkenlassen von Lichtstrahlung einer ersten Wellenlänge und aus dem zweiten in den ersten Zustand überführt werden kann durch Einwirkenlassen von Lichtstrahlung einer zweiten Wellenlänge; wobei die Belichtung eine Konformationsänderung an der Bindungsstelle des immobilisierten Elements induziert, die zu einer Änderung der Bindungsaffinität des immobilisierten Elements, gegenüber dem genannten Analyten führt, wodurch das genannte immobilisierte Element in dem ersten Zustand eine hohe Bindungsaffinität gegenüber dem genannten Analyten aufweist, sodass der Analyt im wesentlichen an das immobilisierte Element gebunden bleibt, und das genannte immobilisierte Element in dem genannten zweiten Zustand eine niedrige Bindungsaffinität gegenüber dem genannten Analyten aufweist, sodass der gebundene Analyt leicht dissoziiert; und
- (ii) Redox-Moleküle, die ihren Redox-Zustand ändern können durch Aufnahme von Elektronen aus der Elektrode oder Abgabe von Elektronen an die Elektrode;

wobei die Bildung eines Paar-Komplexes an der Elektrode eine Änderung der elektrischen Antwort (Reaktion) des Systems mit sich bringt, wodurch das Vorhandensein und gegebenenfalls die Konzentration des genannten Analyten in dem Medium bestimmt werden können.

25

2. System nach Anspruch 1, worin die verbindende Gruppe die folgende allgemeine Formel (I) hat:

30



worin bedeuten:

35

Z für den Fall, dass das Elektrodenmaterial ein Metall ist, einen Schwefel enthaltenden Rest, der durch chemische Assoziation, Anlagerung oder Chemisorption an das genannte Metall gebunden sein kann; und für den Fall, dass das Elektrodenmaterial Glas ist, Methoxy- oder Alkoxysilan-Reste, die durch chemische Assoziation, Anlagerung oder Chemisorption an das genannte Glas gebunden sein können;

40

R<sup>1</sup> eine verbindende Gruppe;

Q eine funktionelle Gruppe, die mit einem Rest, der ein Element eines Erkennungspaares ist, eine kovalente Bindung bilden kann.

45

3. System nach Anspruch 1 oder 2 für die Verwendung zur Bestimmung eines Analyten, der ein Element eines Erkennungspaares ist, das ausgewählt ist aus der Gruppe, die besteht aus Antigen-Antikörper, Zucker-Lectin, Ligand-Rezeptor, Biotin-Avidin, Enzym-Substrat, Oligonucleotid-DNA, Oligonucleotid-Protein, Oligonucleotid-Zelle und Substrat-Enzym, wobei das auf der Elektrode immobilisierte Element das andere Element des genannten Paares ist.

50

4. System nach einem der Ansprüche 1 bis 3 zur Bestimmung eines Agens in einer biologischen Probe, das von dem genannten Analyten verschieden ist, wobei die genannte Änderung der elektrischen Antwort als Ergebnis der Bildung des genannten Paar-Komplexes zur indirekten Bestimmung des genannten Agens in der Probe dient.

55

5. System nach einem der Ansprüche 1 bis 4, worin das genannte Redox-Molekül sich in der Lösung frei dreht.

6. System nach einem der Ansprüche 1 bis 4, worin das genannte Redox-Molekül an ein Analyt-Molekül gebunden ist.

7. System nach einem der Ansprüche 1 bis 6, worin das Elektrodenmaterial Gold, Platin oder Silber ist.
8. System nach einem der Ansprüche 1 bis 6, worin das Elektrodenmaterial elektrisch leitendes Glas ist.
- 5 9. Verfahren zur Bestimmung des Vorhandenseins und gegebenenfalls der Konzentration eines Analyten in einem flüssigen Medium, das umfasst:
- (a) das Inkontaktbringen einer Elektrode, an der ein Element eines Erkennungspaares mittels einer verbindenden Gruppe an deren Oberfläche immobilisiert ist, wobei das andere Element des genannten Paares der  
 10 genannte Analyt ist, mit einem Medium, das den zu bestimmenden Analyten umfasst, und mit einem Redox-Molekül, das seinen Redox-Zustand durch Aufnahme von Elektronen aus der Elektrode oder durch Abgabe von Elektronen an die Elektrode ändern kann, wobei das immobilisierte Element des Erkennungspaares aufweist oder gebunden ist an eine Gruppe, die reaktionsfähig bei Einwirkung von Lichtenergie ist; die genannte Gruppe einen ersten und einen zweiten Zustand aufweist und durch Einwirkenlassen von Lichtstrahlung einer  
 15 ersten Wellenlänge aus dem ersten Zustand in den zweiten Zustand überführt werden kann und durch Einwirkenlassen von Lichtstrahlung einer zweiten Wellenlänge aus dem zweiten in den ersten Zustand überführt werden kann, wobei die Belichtung eine Konformationsänderung an der Bindungsstelle des immobilisierten Elements induziert, die zu einer Änderung der Bindungsaffinität des immobilisierten Elements gegenüber dem genannten Analyten führt, wodurch das genannte immobilisierte Element in dem ersten Zustand eine hohe Bindungsaffinität gegenüber dem genannten Analyten aufweist, sodass der Analyt im wesentlichen an das immobilisierte Element gebunden bleibt, und das genannte immobilisierte Element in dem genannten zweiten Zustand eine niedrige Bindungsaffinität gegenüber dem genannten Analyten aufweist, sodass der gebundene Analyt leicht dissoziiert;
- (b) das Inkontaktbringen der genannten Elektrode mit dem genannten Medium und das Messen der genannten elektrischen Antwort;
- (c) das Bestrahlen der genannten Elektrode mit Licht mit einer ersten Wellenlänge;
- (d) das Messen der Änderung der elektrischen Antwort als Ergebnis des Kontakts mit der genannten Lösung, wodurch das Vorhandensein und gegebenenfalls die Konzentration des genannten Analyten bestimmt werden können;
- (e) das Spülen der Elektrode, um so Analyt-Moleküle aus dem die Elektrode umgebenden Medium zu entfernen; und  
 35
- (f) das Bestrahlen der genannten Elektrode mit Licht einer zweiten Wellenlänge, wodurch die Elektrode gebrauchsfertig für die Wiederverwendung ist.
- 40 10. Verfahren nach Anspruch 9 zur Bestimmung eines Analyten, bei dem es sich um ein Element eines Erkennungspaares einer Gruppe von Paaren handelt, die besteht aus Antigen-Antikörper, Zucker-Lectin, Ligand-Rezeptor, Biotin-Avidin, Enzym-Substrat, Oligonucleotid-DNA, Oligonucleotid-Protein, Oligonucleotid-Zelle und Substrat-Enzym; wobei das genannte immobilisierte Element das andere Element des genannten Paares ist.
- 45 11. Verfahren nach Anspruch 9 oder 10 zur Bestimmung eines Agens in einer Probe, bei dem es sich um den genannten Analyten handelt, wobei das Verfahren umfasst das Inkontaktbringen der Elektrode mit der genannten Probe oder einem Teil derselben, die (der) das genannte Agens enthält.
- 50 12. Verfahren nach Anspruch 9 oder 11 zur Bestimmung eines Agens in einer Probe, bei dem es sich um ein von dem genannten Analyten verschiedenes Molekül handelt, durch Inkontaktbringen einer Lösung, die das genannte Agens umfasst, mit einer Reagens-Lösung, was entweder zur Bildung des genannten Analyten in der Reagens-Lösung oder zur Herabsetzung der freien Analyt-Konzentration in der genannten Reagenslösung führt; wobei das Verfahren umfasst:
- 55 (a) die Umsetzung der genannten Probe oder eines Teils derselben, die (der) das genannte Agens umfasst, mit der genannten Reagens-Lösung;
- (b) das Inkontaktbringen der Elektrode mit dem Reaktionsprodukt der Stufe (a);

EP 0 668 502 B1

(c) die Messung der Änderung der elektrischen Antwort, die aus dem Kontakt der Elektrode mit dem genannten Reaktionsprodukt resultiert, wodurch das Vorhandensein und gegebenenfalls die Konzentration des genannten Agens in der genannten Probe bestimmt wird.

- 5 13. Verfahren nach Anspruch 12, worin der genannte Analyt ein Molekül ist, das sich an das genannte Agens bindet.
14. Verfahren nach Anspruch 13, worin das genannte Agens die gleiche Bindungs-Charakteristik gegenüber dem genannten Analyten wie das immobilisierte Element aufweist.
- 10 15. Verfahren nach Anspruch 12, worin das genannte Agens ein Molekül ist,
- (i) das entweder durch ein Enzym in Produkte zerlegt worden ist, von denen eines das genannte Agens ist;
- (ii) oder ein Vorläufer-Molekül ist, das durch ein Enzym in das genannte Agens umgewandelt wird;
- 15 wobei die genannte Reagens-Lösung das genannte Enzym umfasst.
16. Verfahren nach einem der Ansprüche 9 bis 15, worin das Redox-Molekül sich in der Lösung frei dreht.
- 20 17. Verfahren nach einem der Ansprüche 9 bis 15, worin das Redox-Molekül Teil eines modifizierten Analyten ist, der ein an ein Redox-Molekül gebundenes Analyt-Molekül umfasst.
18. Verfahren nach Anspruch 17, worin die Elektrode gleichzeitig mit dem Medium, in dem der Analyt bestimmt werden soll, und mit dem genannten modifizierten Analyten in Kontakt gebracht wird.
- 25 19. Verfahren nach Anspruch 17, worin die Elektrode zuerst mit dem Medium, in dem der Analyt bestimmt werden soll, und danach mit dem genannten modifizierten Analyten in Kontakt gebracht wird.
- 30 20. Verfahren nach einem der Ansprüche 9 bis 19, worin die Analyt-Moleküle konjugiert oder komplex gebunden sind mit einem großen Molekül oder einer Gruppe von Molekülen, wodurch die Empfindlichkeit des Verfahrens erhöht wird.
- 35 21. Im wesentlichen wiederverwendbare Elektrode für die Verwendung in dem elektrobiochemischen System nach einem der Ansprüche 1 bis 8 zur Bestimmung des Vorhandenseins und gegebenenfalls der Konzentration eines Analyten in einem flüssigen Medium, wobei die Elektrode umfasst ein Elektrodenmaterial, das in elektrischer Verbindung stehen kann mit einem Redox-Molekül, wobei an dem Elektrodenmaterial eine Schicht aus einem Element eines Erkennungspaares auf der Oberfläche der Elektrode mittels einer verbindenden Gruppe immobilisiert ist und das andere Element des Paares der genannte Analyt ist; wobei die elektrische Verbindung zwischen dem Redox-Molekül und dem Elektroden-Material modifiziert ist durch Bindung des genannten Elements an den genannten Analyten; das immobilisierte Element aufweist oder gebunden ist an eine Gruppe, die reaktionsfähig ist bei Einwirkung von Lichtenergie, wobei die genannte Gruppe einen ersten und einen zweiten Zustand aufweist und durch Einwirkenlassen von Lichtstrahlung mit einer ersten Wellenlänge aus dem ersten Zustand in den zweiten Zustand überführt werden kann und durch Einwirkenlassen von Lichtstrahlung einer zweiten Wellenlänge aus dem zweiten Zustand in den ersten Zustand überführt werden kann; wobei die Belichtung eine Konformationsänderung an der Bindungsstelle des immobilisierten Elements induziert, die zu einer Änderung der Bindungsaffinität des immobilisierten Elements gegenüber dem genannten Analyten führt, wodurch das genannte immobilisierte Element in dem ersten Zustand eine hohe Bindungsaffinität gegenüber dem genannten Agens aufweist, sodass der gebundene Analyt nicht leicht dissoziiert, und das genannte immobilisierte Element in dem genannten zweiten Zustand eine niedrige Bindungsaffinität gegenüber dem genannten Analyten aufweist, sodass das gebundene Agens leicht dissoziiert und aus dem System entfernt werden kann und die Elektrode dann Licht einer zweiten Wellenlänge ausgesetzt werden kann, die eine Änderung in den genannten ersten Zustand induziert, wodurch die Elektrode gebrauchsfertig für die Wiederverwendung wird, wodurch das Vorhandensein und gegebenenfalls die Konzentration des genannten Analyten in einem die Elektrode umgebenden Medium erneut bestimmt werden kann.
- 55 22. Elektrode nach Anspruch 21, worin die verbindende Gruppe die folgende allgemeine Formel (I) hat:

worin bedeuten:

5

Z für den Fall, dass das Elektrodenmaterial ein Metall ist, einen Schwefel enthaltenden Rest, der durch chemische Assoziation, Anlagerung oder Chemisorption an das genannte Metall gebunden sein kann; und für den Fall, dass das Elektrodenmaterial Glas ist, Methoxy- oder Alkoxysilan-Reste, die durch chemische Assoziation, Anlagerung oder Chemisorption an das genannte Glas gebunden sein können;

10

R<sup>1</sup> eine verbindende Gruppe;

Q eine funktionelle Gruppe, die mit einem Rest, der ein Element eines Erkennungspaares ist, eine kovalente Bindung bilden kann.

15

23. Elektrode nach Anspruch 21 oder 22, worin die genannte Gruppe, die reaktionsfähig ist bei Einwirkung von Lichtenergie ausgewählt ist aus der Gruppe, die besteht aus Azobenzolen, Spiropyranen, Fulgiden, Thiophenfulgiden und Malachitgrün.

20

24. Verfahren zur Herstellung einer Elektrode nach Anspruch 22 oder 23, das umfasst:

(a) das Immobilisieren der genannten verbindenden Gruppe an dem Elektrodenmaterial durch chemische Assoziation, Anlagerung oder Chemisorption des Schwefel enthaltenden Restes oder des funktionalisierten Alkoxysilans jeweils an dem Metall- oder Glas-Elektrodenmaterial;

25

(b) das chemische Modifizieren eines Elements des genannten Erkennungspaares mit einer durch Licht isomerisierbaren Gruppe, wodurch das modifizierte Element seine Bindungsaffinität gegenüber dem anderen Element des Erkennungspaares durch Einwirkenlassen von Lichtenergie ändert; und

30

(c) das Binden des modifizierten Elements des Erkennungspaares an die genannte funktionelle Gruppe der verbindenden Gruppe, die an der Elektrode immobilisiert ist.

25. Verfahren zur Herstellung einer Elektrode nach Anspruch 22 oder 23, das umfasst:

35

(a) das Immobilisieren der genannten verbindenden Gruppe an dem Elektrodenmaterial durch chemische Assoziation, Anlagerung oder Chemisorption des Schwefel enthaltenden Restes oder des funktionalisierten Alkoxysilans jeweils an das Metall- oder Glas-Elektrodenmaterial;

40

(b) das Binden eines Elements des Erkennungspaares an die genannte funktionelle Gruppe der verbindenden Gruppe, die an der Elektrode immobilisiert ist; und

45

(c) das chemische Modifizieren des genannten Elements des Erkennungspaares mit einer durch Licht isomerisierbaren Gruppe, wodurch das modifizierte Element seine Bindungsaffinität ändert gegenüber dem anderen Element des Erkennungspaares durch Einwirkenlassen von Lichtenergie.

26. Verfahren nach Anspruch 25, worin die Stufe (b) der Stufe (a) vorhergeht.

#### Revendications

50

1. Système électrochimique pour déterminer la présence et éventuellement la concentration d'un analyte dans un milieu liquide, l'analyte étant un membre d'une paire de reconnaissance, le système comprenant :

55

(i) une électrode sur laquelle est immobilisé l'autre membre d'une paire de reconnaissance, étant immobilisé sur la surface de l'électrode au moyen d'un groupe de liaison, tel que la présence dudit analyte dans le milieu entraîne la formation de complexes de paires sur l'électrode, dans lequel le membre de la paire de reconnaissance immobilisé présente ou est lié à un groupe réactif à une exposition à une énergie lumineuse ; ledit



groupe ayant un premier et un deuxième état et est capable d'être converti du premier état au deuxième état par exposition à un rayonnement lumineux d'une première longueur d'onde et du deuxième au premier état par exposition à un rayonnement lumineux d'une deuxième longueur d'onde ; l'exposition induisant un changement de conformation du site de liaison du membre immobilisé entraînant un changement dans l'affinité du membre immobilisé pour la liaison audit analyte, moyennant quoi dans le premier état ledit membre immobilisé présente une forte affinité de liaison audit analyte telle que l'analyte reste essentiellement lié au membre immobilisé et dans ledit deuxième état, ledit membre immobilisé présente une faible affinité de liaison audit analyte, telle que l'analyte lié est facilement dissocié ; et  
 (ii) des molécules redox qui peuvent changer leur état redox en acceptant des électrons de l'électrode ou en lui donnant des électrons ;

la formation d'un complexe de paire sur l'électrode conduit à un changement de la réponse électrique du système, moyennant quoi la présence et éventuellement la concentration dudit analyte dans le milieu peut (peuvent) être déterminée(s).

2. Système selon la revendication 1 dans lequel le groupe de liaison a la formule générale suivante (I) :



dans laquelle :

Z, dans le cas où le matériau de l'électrode est un métal, représente un fragment contenant du soufre qui est capable d'association chimique avec ledit métal, de fixation audit métal ou de chimisorption sur ledit métal ; et dans le cas où le matériau de l'électrode est le verre, représente des résidus méthoxy ou alcoxysilane qui sont capable d'association chimique avec ledit verre, de fixation audit verre, ou de chimisorption sur ledit verre ; R<sup>1</sup> représente un groupe de liaison ;

Q est un groupe fonctionnel qui est capable de former une liaison covalente avec un fragment étant un membre d'une paire de reconnaissance.

3. Système selon la revendication 1 ou 2 pour une utilisation dans la détermination d'un analyte étant un membre d'une paire de reconnaissance, la paire étant choisie parmi le groupe constitué des antigène-anticorps, sucrélectine, ligand-récepteur, biotine-avidine, enzyme-substrat, oligonucléotide-ADN, oligonucléotide-protéine, oligonucléotide-cellule et substrat-enzyme, le membre immobilisé sur l'électrode étant l'autre membre de ladite paire.

4. Système selon l'une quelconque des revendications 1 à 3 pour la détermination d'un agent dans un échantillon biologique, dans lequel ledit agent est différent dudit analyte, ledit changement de la réponse électrique en raison de la formation dudit complexe de paire sert à la détermination indirecte dudit agent dans l'échantillon.

5. Système selon l'une quelconque des revendications 1 à 4 dans lequel ladite molécule redox est en mouvement libre dans la solution.

6. Système selon l'une quelconque des revendications 1 à 4, dans lequel ladite molécule redox est liée à une molécule d'analyte.

7. Système selon l'une quelconque des revendications 1 à 6, dans lequel le matériau de l'électrode est de l'or, du platine ou de l'argent.

8. Système selon l'une quelconque des revendications 1 à 6, dans lequel le matériau de l'électrode est un verre conducteur.

9. Procédé pour déterminer la présence et éventuellement la concentration d'un analyte dans un milieu liquide comprenant :

(a) la mise en contact d'une électrode sur laquelle est immobilisé un membre d'une paire de reconnaissance, étant immobilisé sur la surface de l'électrode au moyen d'un groupe de liaison, l'autre membre de ladite paire étant ledit analyte avec un milieu comprenant l'analyte à déterminer et avec une molécule redox capable de

- modifier son état redox en acceptant des électrons de l'électrode ou en lui donnant des électrons, dans lequel le membre immobilisé de la paire de reconnaissance présente ou est lié à un groupe réactif à l'exposition à une énergie lumineuse ; ledit groupe ayant un premier et un deuxième état et est capable d'être converti du premier état au deuxième état par exposition à un rayonnement lumineux d'une première longueur d'onde et du deuxième au premier état par exposition à un rayonnement lumineux d'une deuxième longueur d'onde ; l'exposition induisant un changement de conformation du site de liaison du membre immobilisé entraînant un changement dans l'affinité du membre immobilisé pour la liaison audit analyte, moyennant quoi dans le premier état ledit membre immobilisé présente une forte affinité de liaison audit analyte telle que l'analyte reste essentiellement lié au membre immobilisé et dans ledit deuxième état, ledit membre immobilisé présente une faible affinité de liaison audit analyte, telle que l'analyte lié est facilement dissocié ; et
- (b) la mise en contact de ladite électrode avec ledit milieu et la mesure de ladite réponse électrique ;
- (c) l'irradiation de ladite électrode par la lumière ayant une première longueur d'onde ;
- (d) la mesure du changement de la réponse électrique en raison du contact avec ladite solution, moyennant quoi la présence et éventuellement la concentration dudit analyte peut(peuvent) être déterminée(s) ;
- (e) le rinçage de l'électrode de façon à éliminer les molécules d'analyte du milieu entourant l'électrode ; et
- (f) l'irradiation de ladite électrode par la lumière ayant une deuxième longueur d'onde, moyennant quoi l'électrode est prête pour une nouvelle utilisation.
10. Procédé selon la revendication 9 pour la détermination d'un analyte étant un membre d'une paire de reconnaissance du groupe des paires constitué des antigène-anticorps, sucre-lectine, ligand-récepteur, biotine-avidine, enzyme-substrat, oligonucléotide-ADN, oligonucléotide-protéine, oligonucléotide-cellule et substrat-enzyme ; dans laquelle ledit membre immobilisé est l'autre membre de ladite paire.
11. Procédé selon la revendication 9 ou 10 pour la détermination d'un agent dans un échantillon, ledit agent étant ledit analyte et le procédé comprenant la mise en contact de l'électrode avec ledit échantillon ou une fraction de celui-ci contenant ledit agent.
12. Procédé selon la revendication 9 ou 11 pour la détermination de la présence d'un agent dans un échantillon, l'agent étant une molécule autre que ledit analyte, la mise en contact d'une solution comprenant ledit agent avec une solution de réactif conduisant soit à la formation dudit analyte dans la solution de réaction ou à la réduction de la concentration en analyte libre dans ladite solution de réactif ; le procédé comprenant :
- (a) la réaction dudit échantillon ou d'une fraction de celui-ci comprenant ledit agent avec ladite solution de réactif ;
- (b) la mise en contact de l'électrode avec le produit de la réaction de (a) ;
- (c) la mesure du changement de la réponse électrique résultant du contact de l'électrode avec ledit produit de réaction, moyennant quoi la présence et éventuellement la concentration dudit agent dans ledit échantillon est (sont) déterminée(s).
13. Procédé selon la revendication 12, dans lequel ledit analyte est une molécule qui se lie audit agent.
14. Procédé selon la revendication 13, dans lequel ledit agent présente les mêmes caractéristiques de liaison audit analyte que le membre immobilisé.
15. Procédé selon la revendication 12, dans lequel ledit agent est une molécule qui est soit :
- (i) cassée par une enzyme en produits, l'un d'entre eux étant ledit agent ;
- (ii) une molécule précurseur qui est convertie par une enzyme pour donner ledit agent ;
- ladite solution de réactif comprenant ladite enzyme.
16. Procédé selon l'une quelconque des revendications 9 à 15, dans lequel la molécule redox est en mouvement libre dans la solution.
17. Procédé selon l'une quelconque des revendications 9 à 15, dans lequel la molécule redox forme une partie d'un analyte modifié comprenant une molécule d'analyte liée à une molécule redox.
18. Procédé selon la revendication 17, dans lequel l'électrode est mise en contact simultanément avec le milieu dans

lequel l'analyte doit être déterminée et avec ledit analyte modifié.

- 5
19. Procédé selon la revendication 17, dans lequel l'électrode est d'abord mise en contact avec le milieu dans lequel l'analyte doit être déterminée, puis avec ledit analyte modifié.
20. Procédé selon l'une quelconque des revendications 9 à 19, dans lequel les molécules d'analyte sont conjuguées ou complexées avec une grande molécule ou un groupe de molécules, moyennant quoi la sensibilité du procédé est accrue.
- 10
21. Electrode substantiellement réutilisable dans le système électrochimique selon l'une quelconque des revendications 1 à 8 pour déterminer la présence et éventuellement la concentration d'un analyte dans un milieu liquide, l'électrode comprenant un matériau d'électrode capable d'établir une communication électrique avec une molécule redox ; une couche d'un membre d'une paire de reconnaissance étant immobilisée sur le matériau de l'électrode, étant immobilisé sur la surface de l'électrode au moyen d'un groupe de liaison, l'autre membre de la paire étant ledit analyte ; la communication électrique entre la molécule redox et le matériau de l'électrode étant modifiée par la liaison dudit membre audit analyte ; le membre immobilisé présente ou est lié à un groupe réactif à une exposition à une énergie lumineuse, ledit groupe ayant un premier et un deuxième état et est capable d'être converti du premier état au deuxième état par exposition à un rayonnement lumineux d'une première longueur d'onde et du deuxième au premier état par exposition à un rayonnement lumineux d'une deuxième longueur d'onde ; l'exposition induisant un changement de conformation du site de liaison du membre immobilisé entraînant un changement dans l'affinité du membre immobilisé pour la liaison audit analyte, moyennant quoi dans le premier état ledit membre immobilisé présente une forte affinité de liaison audit agent telle que l'analyte lié n'est pas facilement dissocié et dans ledit deuxième état, ledit membre immobilisé présente une faible affinité de liaison audit analyte, telle que l'agent lié est facilement dissocié et peut être éliminé du système et que l'électrode peut ensuite être exposée à la lumière d'une deuxième longueur d'onde induisant un changement dudit premier état, moyennant quoi l'électrode sera prête à être réutilisée, moyennant quoi la présence et éventuellement la concentration dudit analyte dans un milieu entourant l'électrode peut(peuvent) à nouveau être déterminée(s).
- 15
- 20
- 25

- 30
22. Electrode selon la revendication 21, dans laquelle le groupe de liaison présente la formule générale suivante (I) :

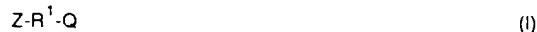

35

dans laquelle :

Z, dans le cas où le matériau de l'électrode est un métal, représente un fragment contenant du soufre qui est capable d'association chimique avec ledit métal, de fixation audit métal ou de chimisorption sur ledit métal ; et dans le cas où le matériau de l'électrode est du verre, représente des résidus méthoxy ou alcoxysilane qui sont capable d'association chimique avec ledit verre, de fixation audit verre ou de chimisorption sur ledit verre ; R<sup>1</sup> représente un groupe de liaison ; Q est un groupe fonctionnel qui est capable de former une liaison covalente avec un fragment étant un membre d'une paire de reconnaissance.

40

- 45
23. Electrode selon la revendication 21 ou 22, dans laquelle ledit groupe réactif à l'exposition à l'énergie lumineuse est choisi parmi le groupe constitué des azobenzènes, des spiropyranes, des fulgides, des thiophène-fulgides et du vert de malachite.

- 50
24. Procédé pour préparer une électrode selon la revendication 22 ou 23, comprenant :

- (a) l'immobilisation dudit groupe de liaison sur le matériau de l'électrode par association chimique, fixation chimique ou chimisorption du groupe fonctionnel contenant du soufre ou de l'alcoxysilane fonctionnalisé au matériau de l'électrode en métal ou en verre, respectivement ;
- (b) la modification chimique d'un membre de ladite paire de reconnaissance avec un groupe photoisomérisable, moyennant quoi le membre modifié change son affinité de liaison à l'autre membre de la paire de reconnaissance par exposition à l'énergie lumineuse ; et
- (c) la liaison du membre modifié de la paire de reconnaissance audit groupe fonctionnel du groupe de liaison immobilisé sur l'électrode.
- 55

**EP 0 668 502 B1**

**25.** Procédé pour préparer une électrode selon la revendication 22 ou 23, comprenant :

- 5 (a) l'immobilisation dudit groupe de liaison sur le matériau de l'électrode par association chimique, fixation, ou chimisorption du groupe fonctionnel contenant du soufre ou de l'alcoxysilane fonctionnalisé au matériau de l'électrode en métal ou en verre, respectivement ;
- (b) la liaison d'un membre de la paire de reconnaissance audit groupe fonctionnel du groupe de liaison immobilisé sur l'électrode ; et
- 10 (c) la modification chimique dudit membre de la paire de reconnaissance avec un groupe photoisomérisable, moyennant quoi le membre modifié change son affinité de liaison à l'autre membre de la paire de reconnaissance par exposition à l'énergie lumineuse.

**26.** Procédé selon la revendication 25, dans lequel l'étape (b) précède l'étape (a).

15

20

25

30

35

40

45

50

55

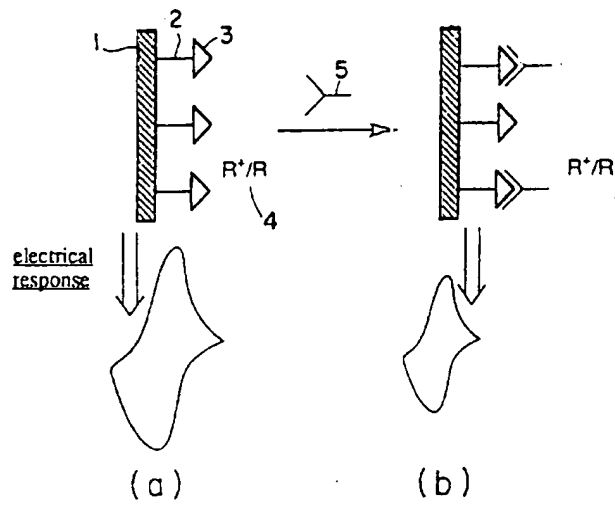

Fig. 1

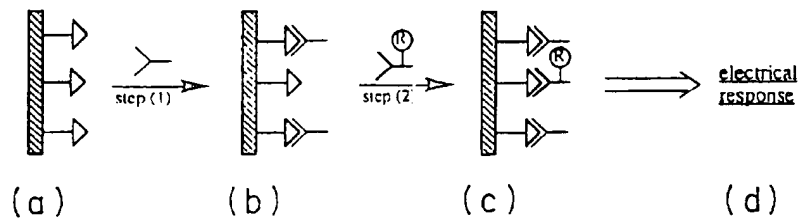

Fig. 2

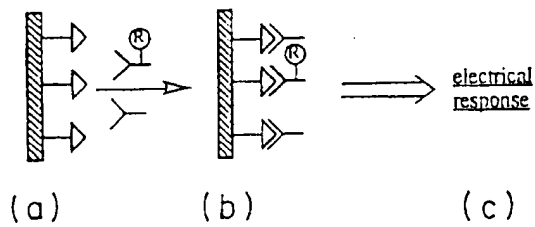

Fig. 3

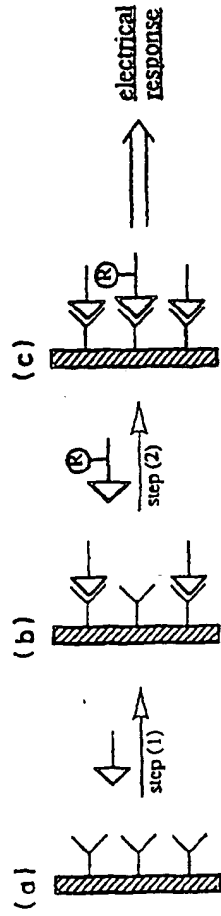

Fig. 4

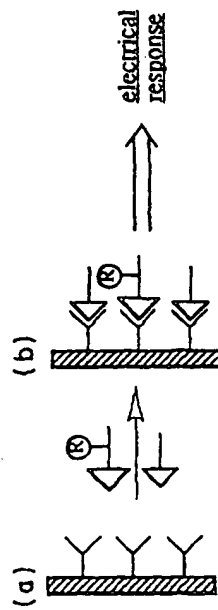

Fig. 5

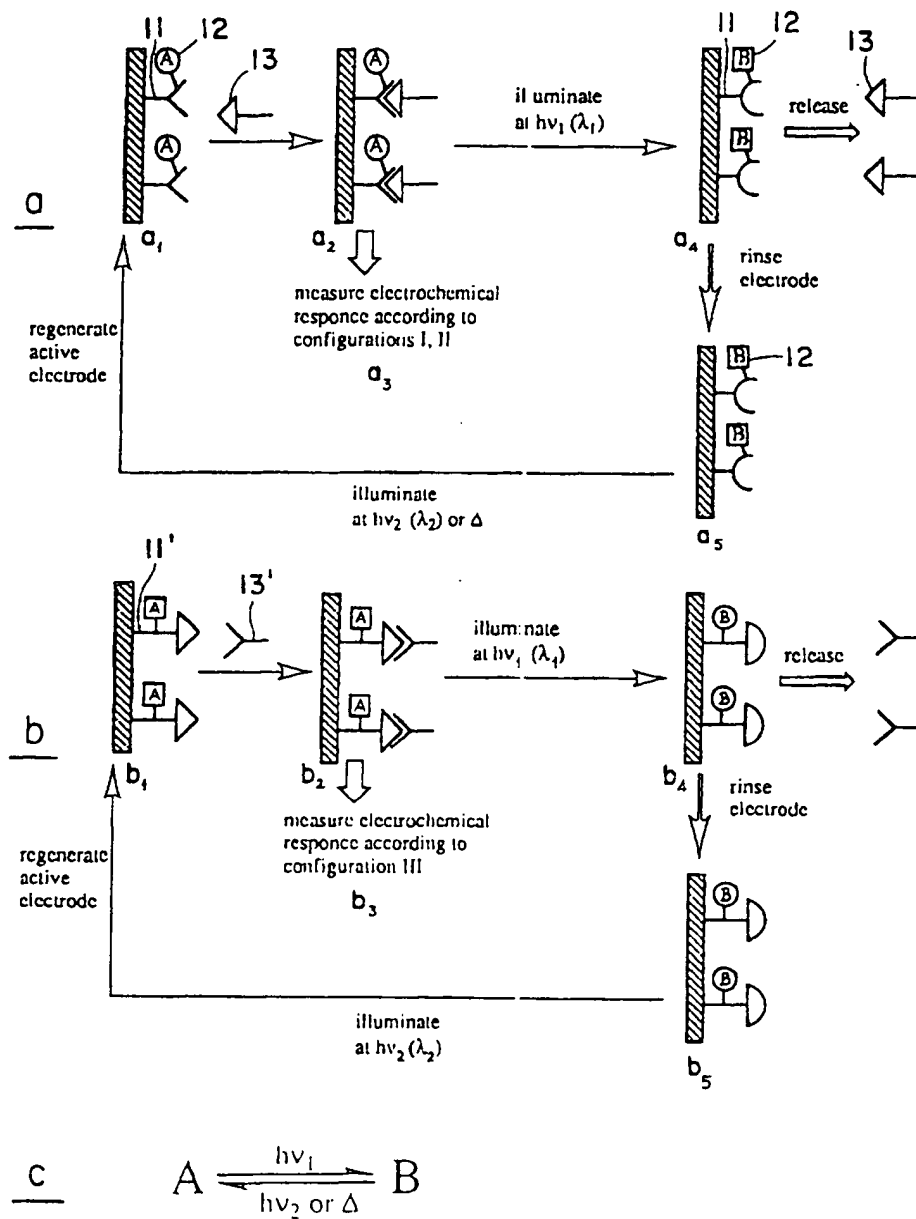

Fig. 6

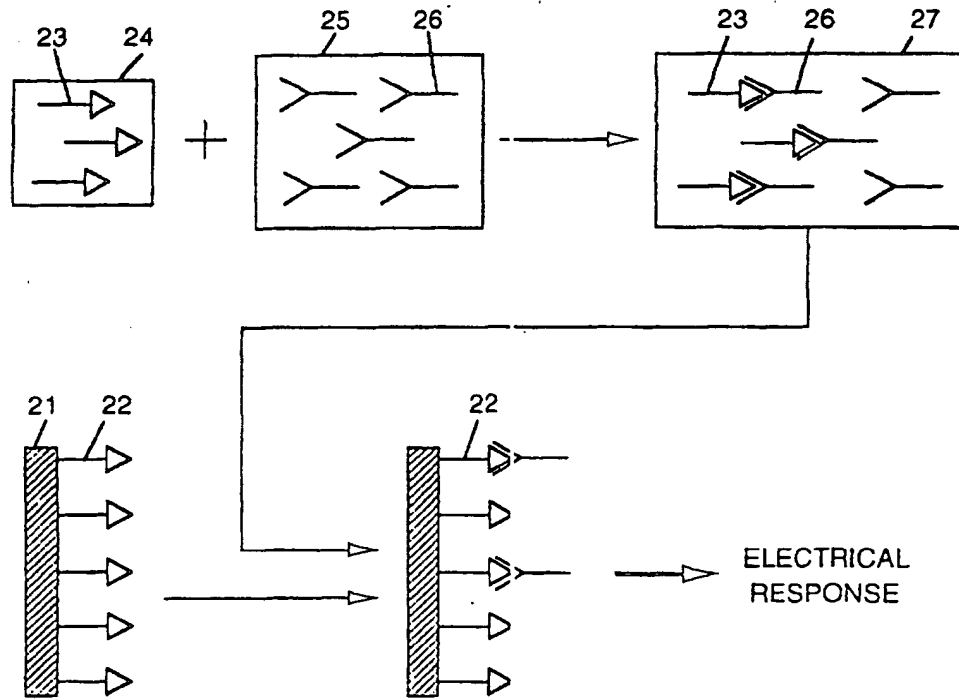

Fig. 7



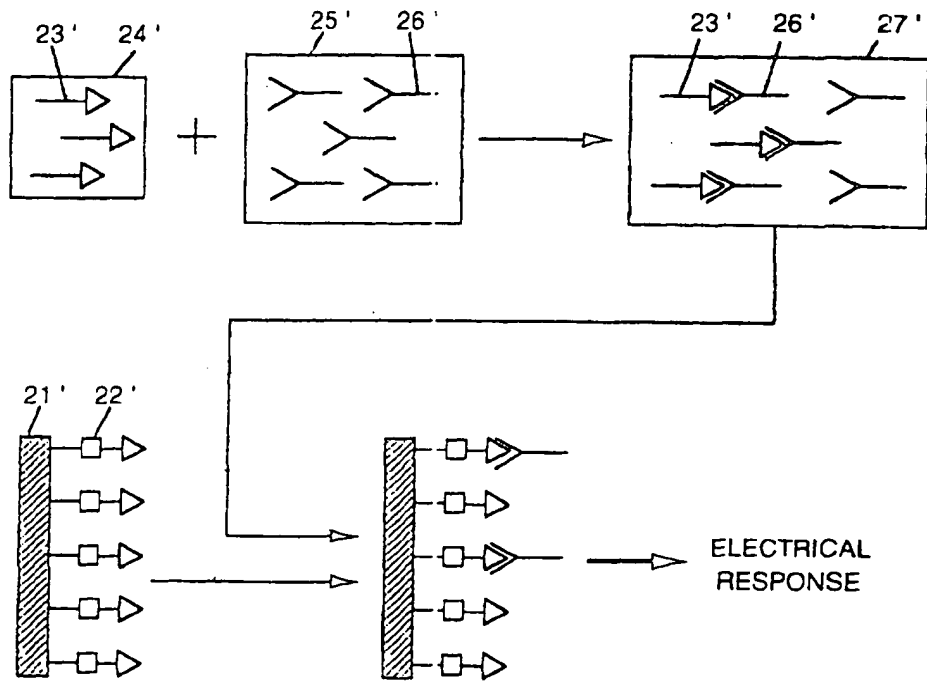

Fig. 8

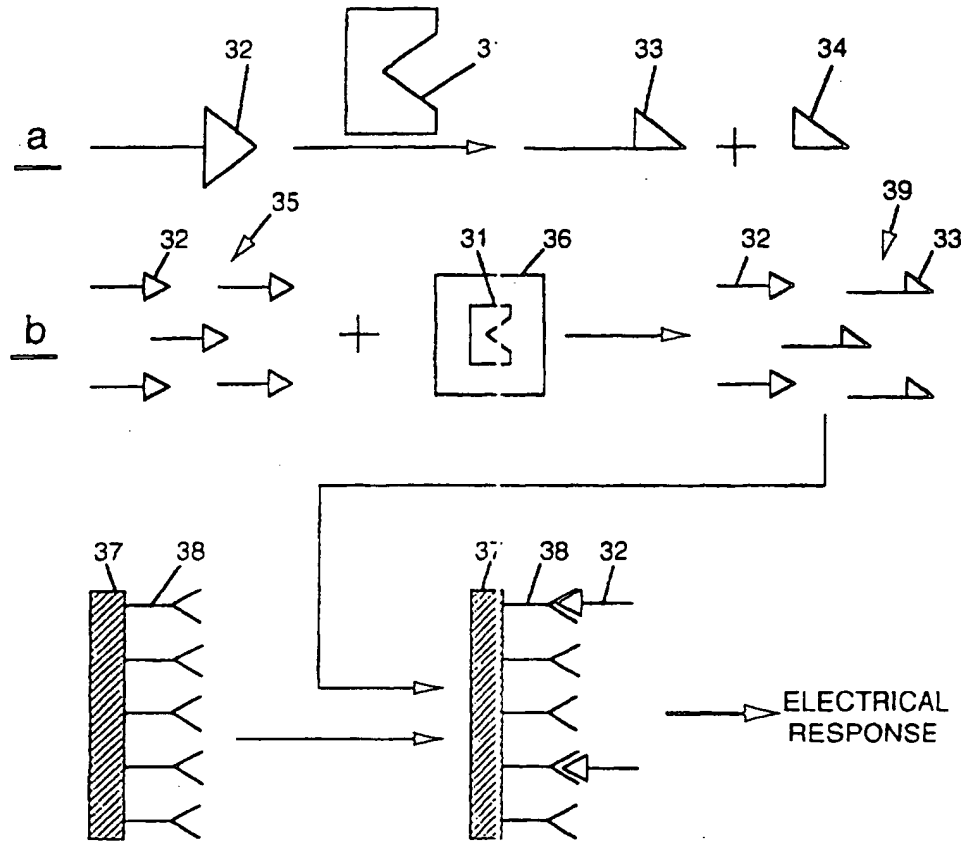

Fig. 9

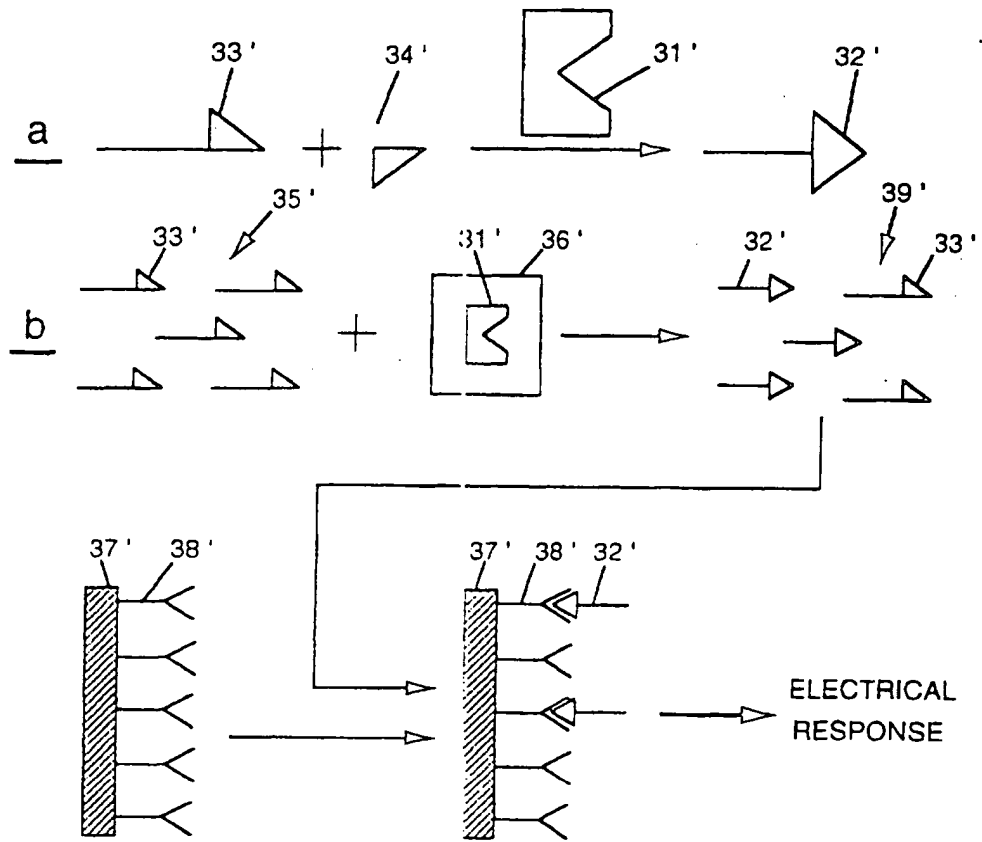

Fig. 10

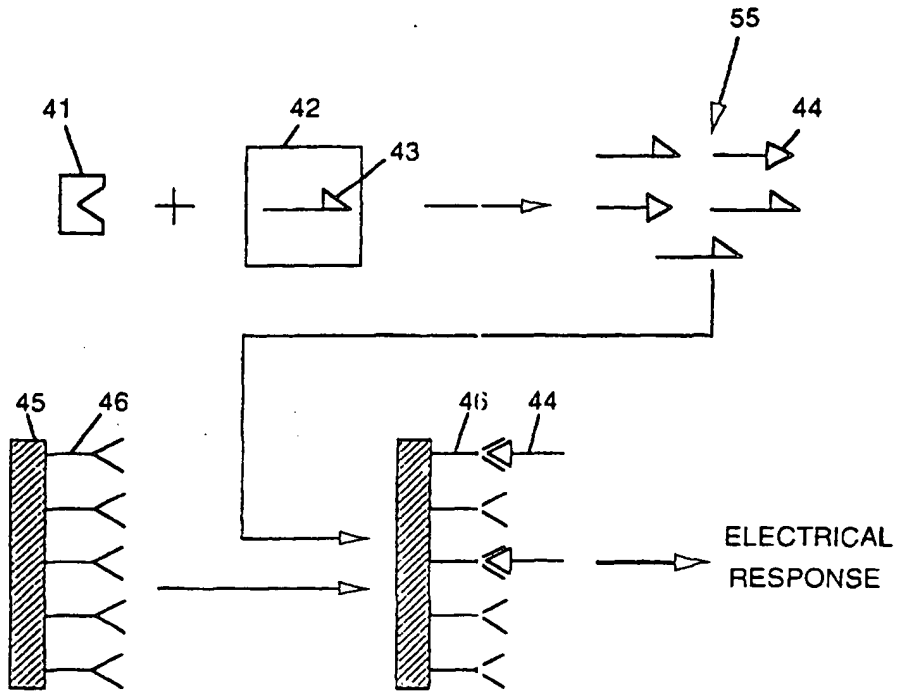

Fig. 11

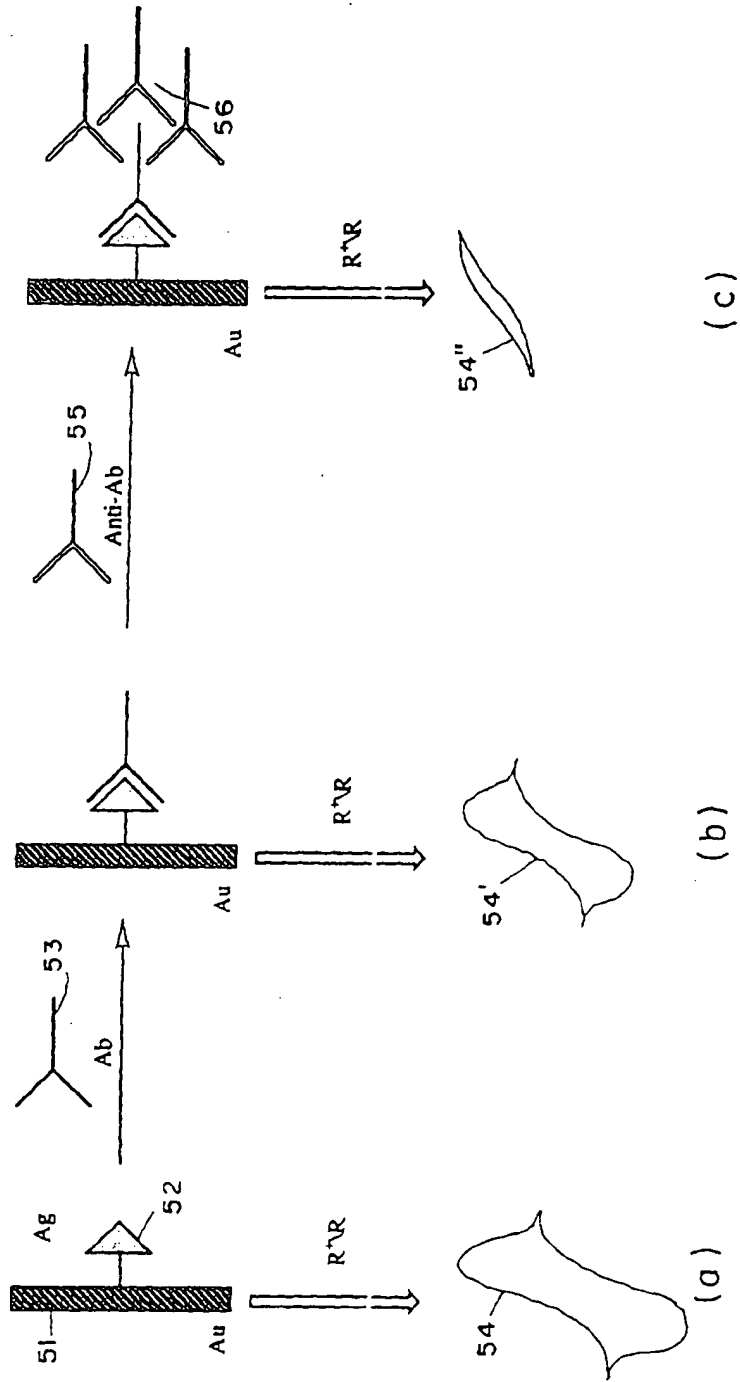

Fig. 12

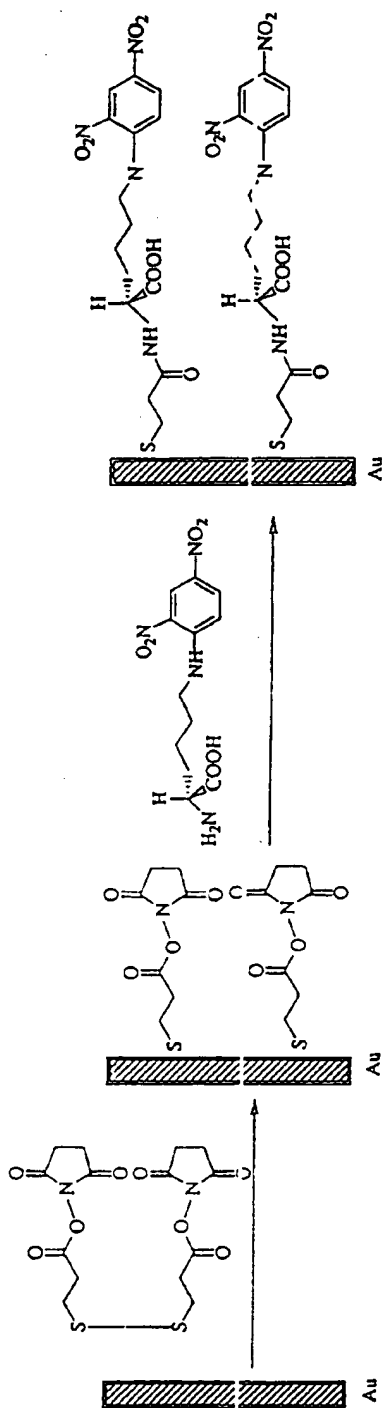

Fig. 13

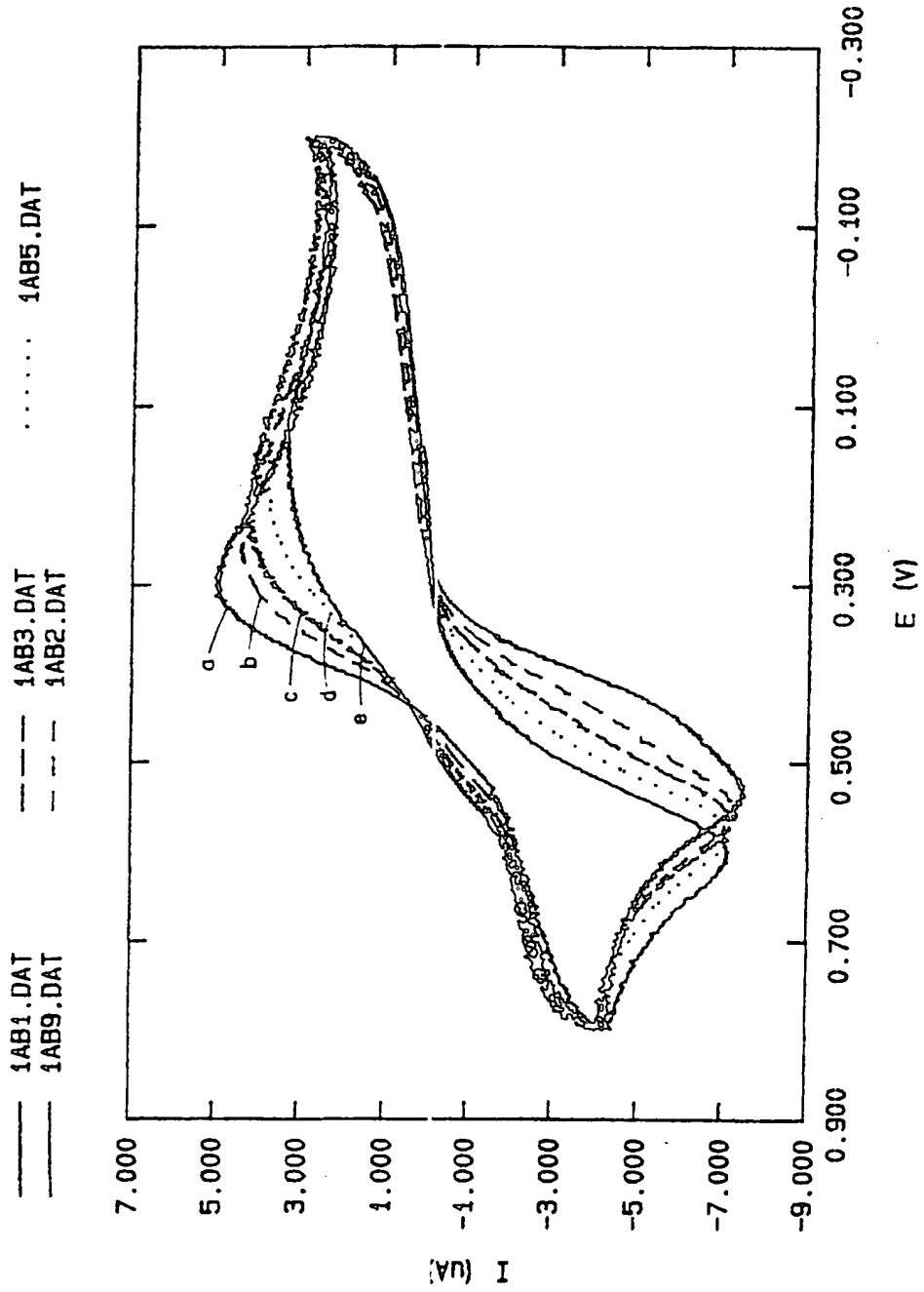

Fig.14a

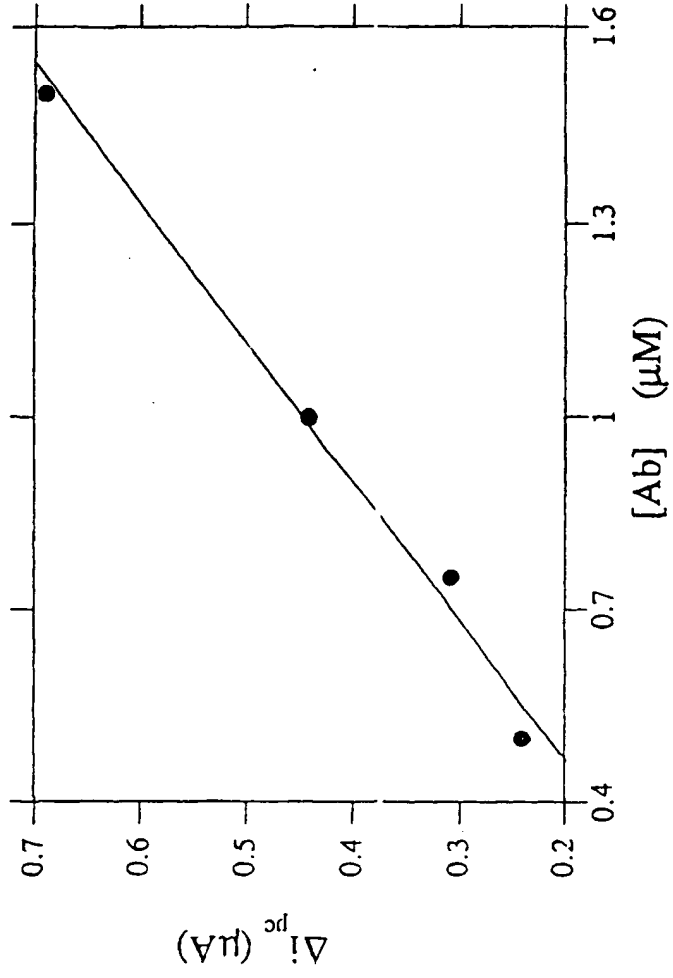

Fig. 14b



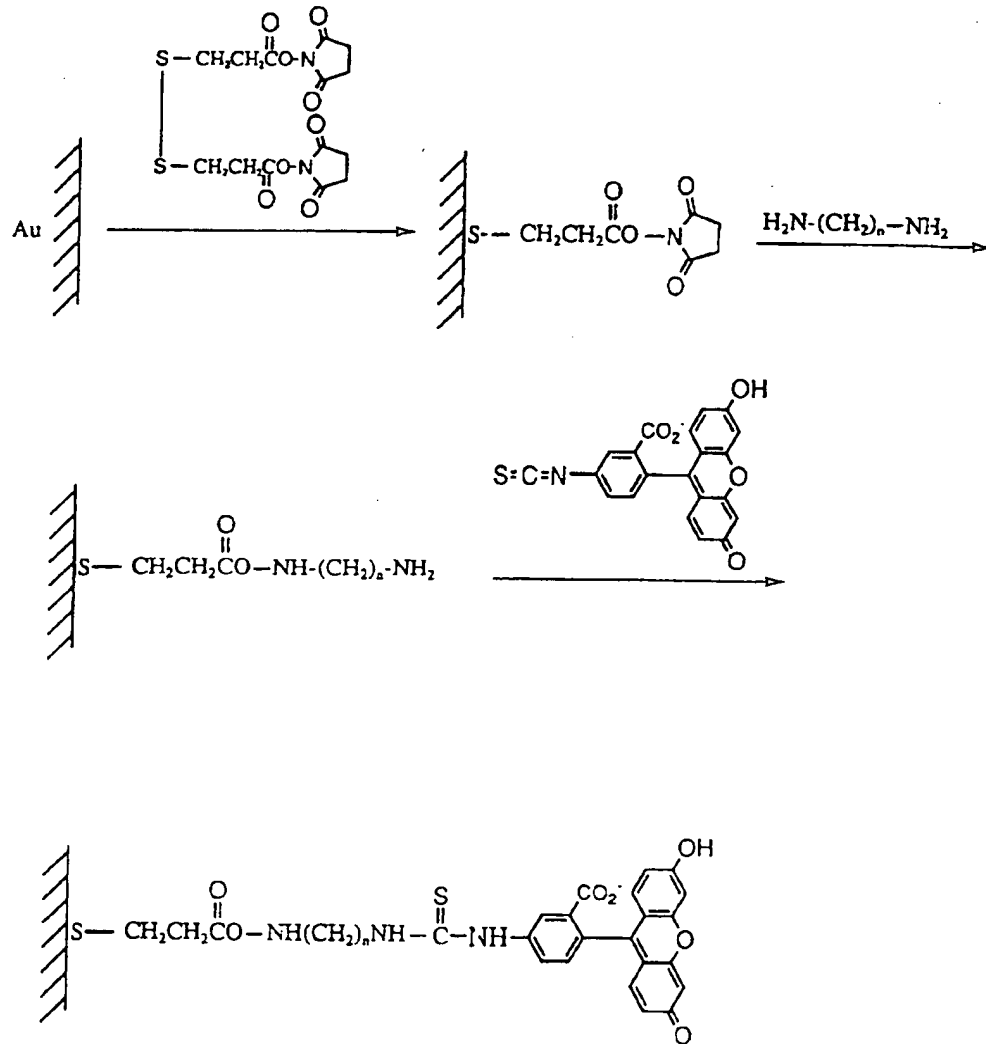

Fig. 15

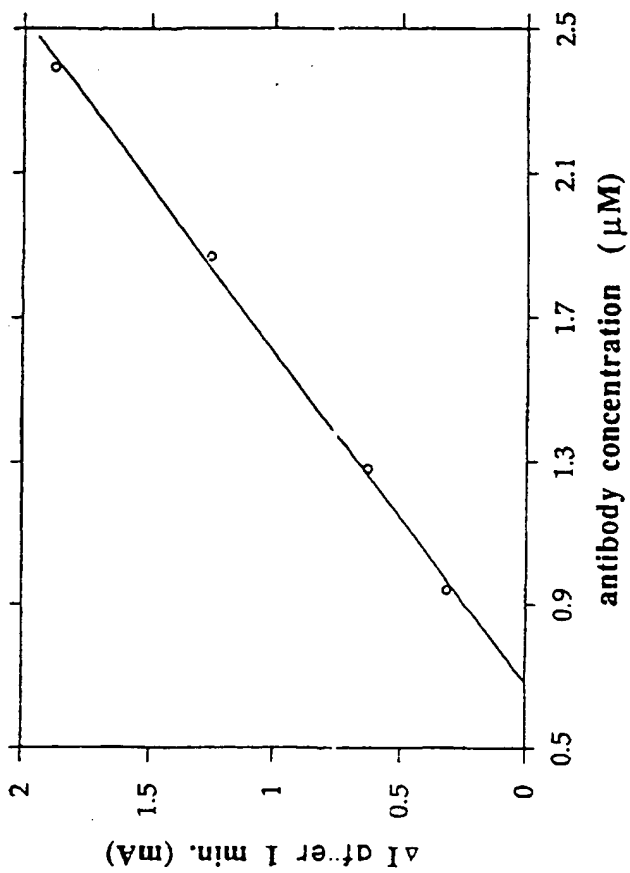

Fig. 16

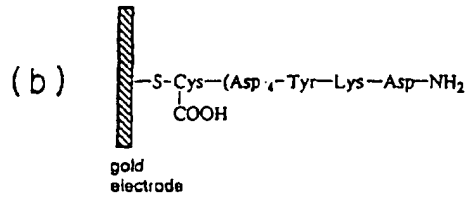
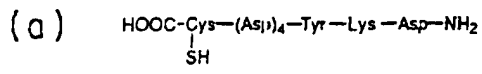
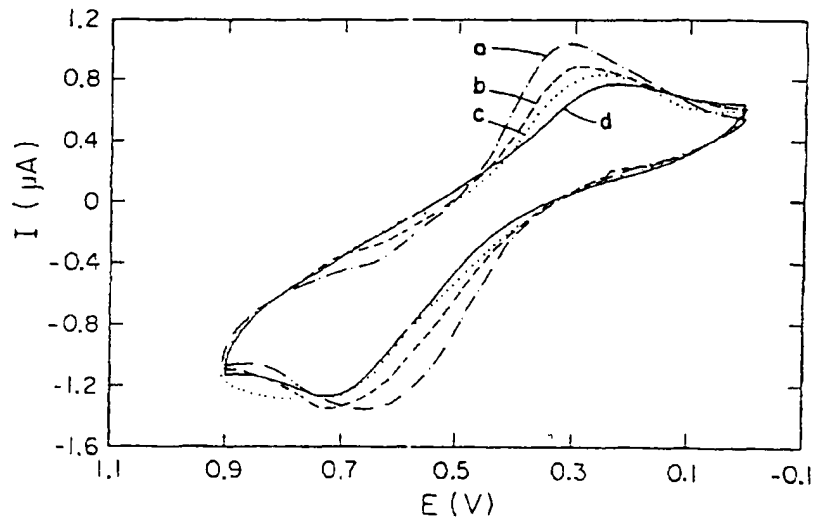

Fig. 17



|   | time, (mins) |
|---|--------------|
| a | 0            |
| b | 3            |
| c | 5            |
| d | 35           |

Fig. 18

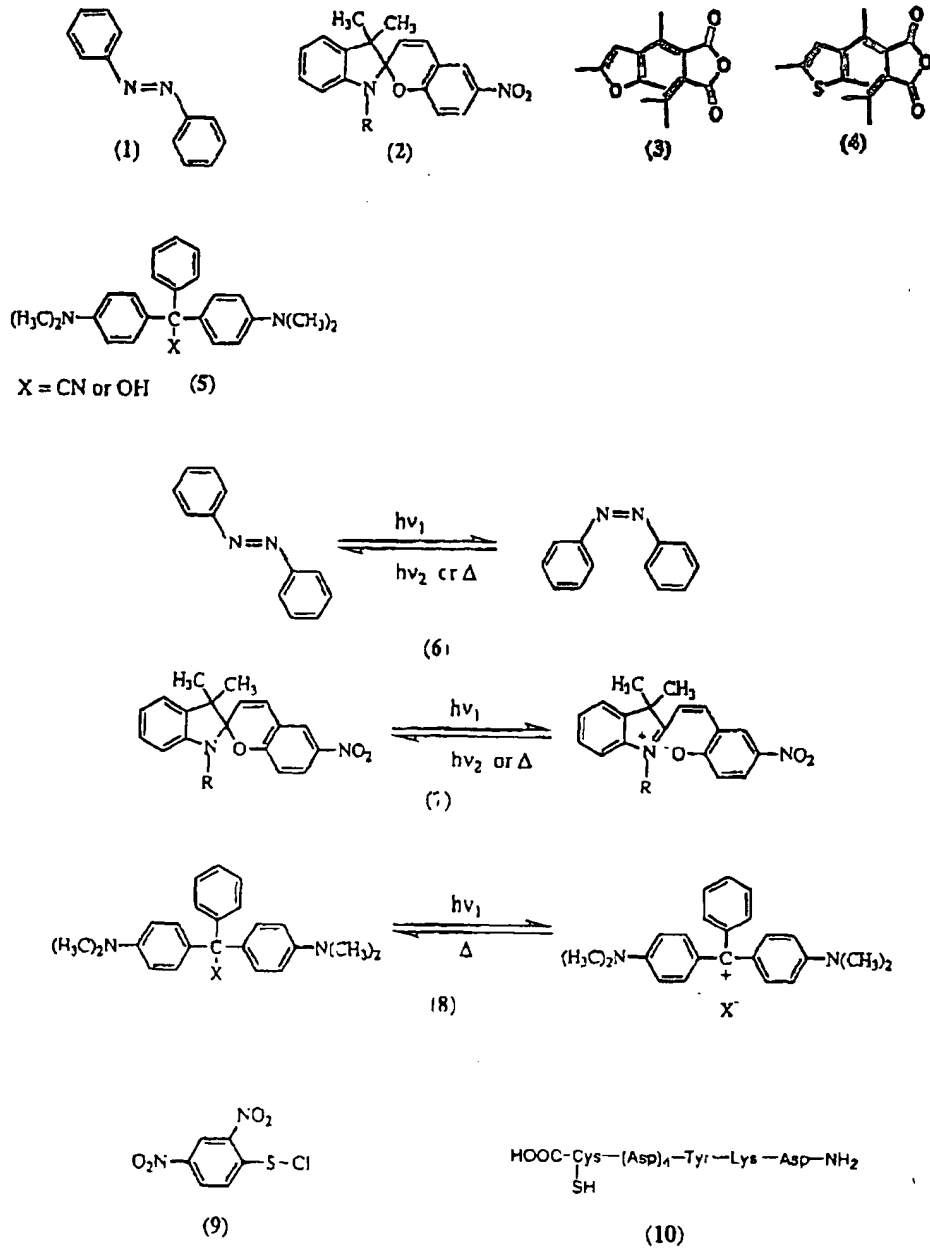
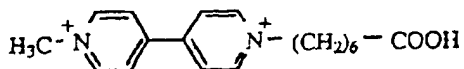
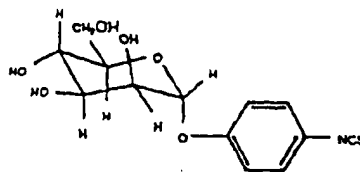

Fig. 19

Fig. 19 (cont.)



(11)



(12)

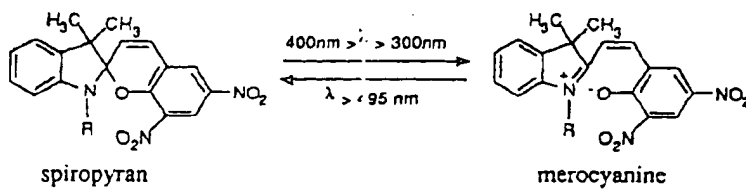

spiropyran

merocyanine

(a)

(b)

(13) R = -CH<sub>3</sub>

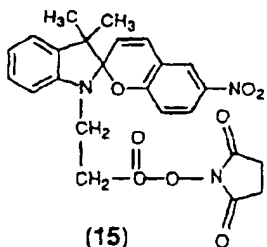
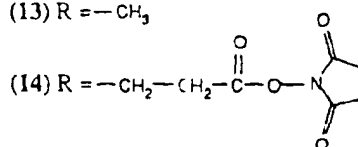

(15)

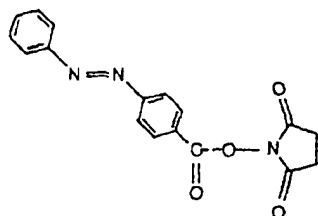

(16)

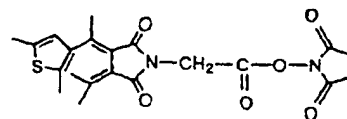

(17)

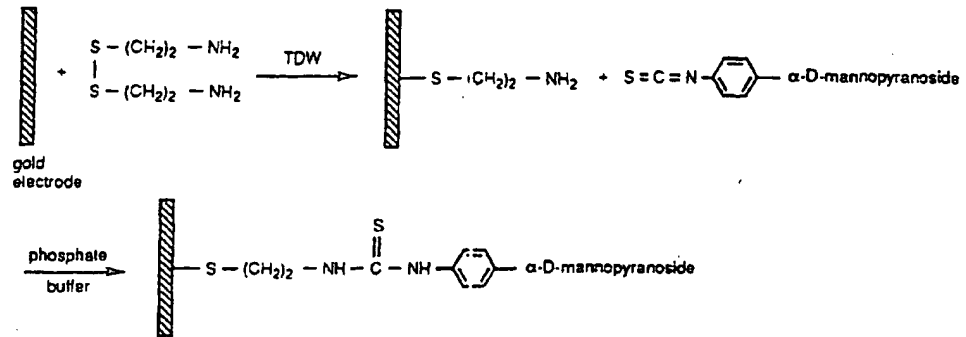

Fig. 20

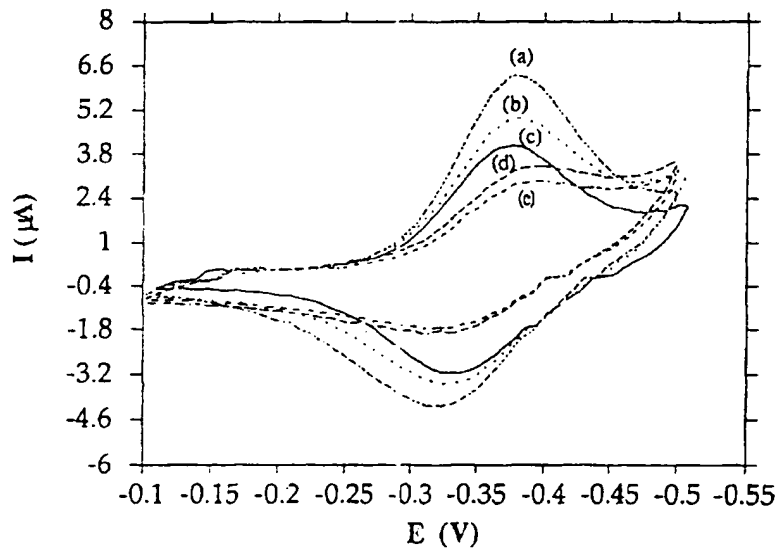

Fig. 21

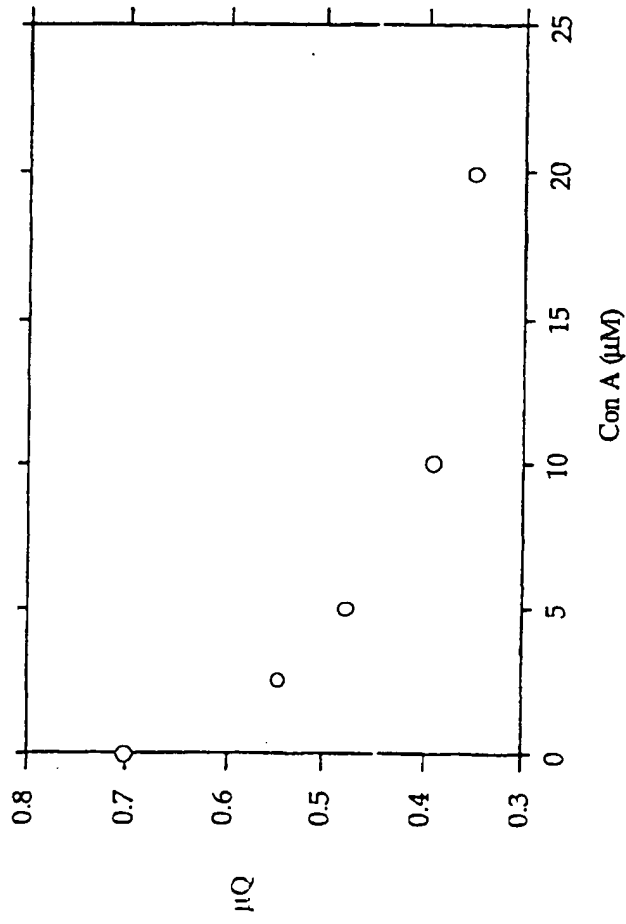

Fig. 22

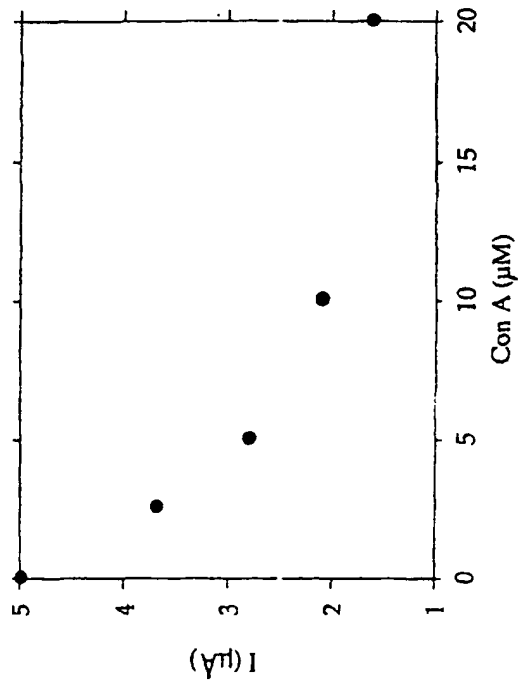

Fig. 23



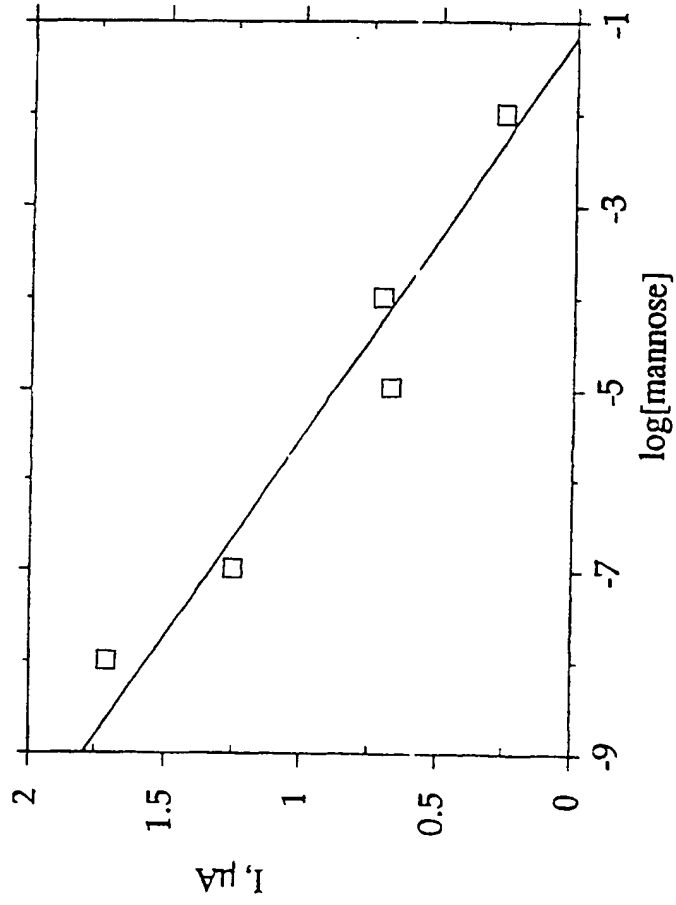

Fig. 24

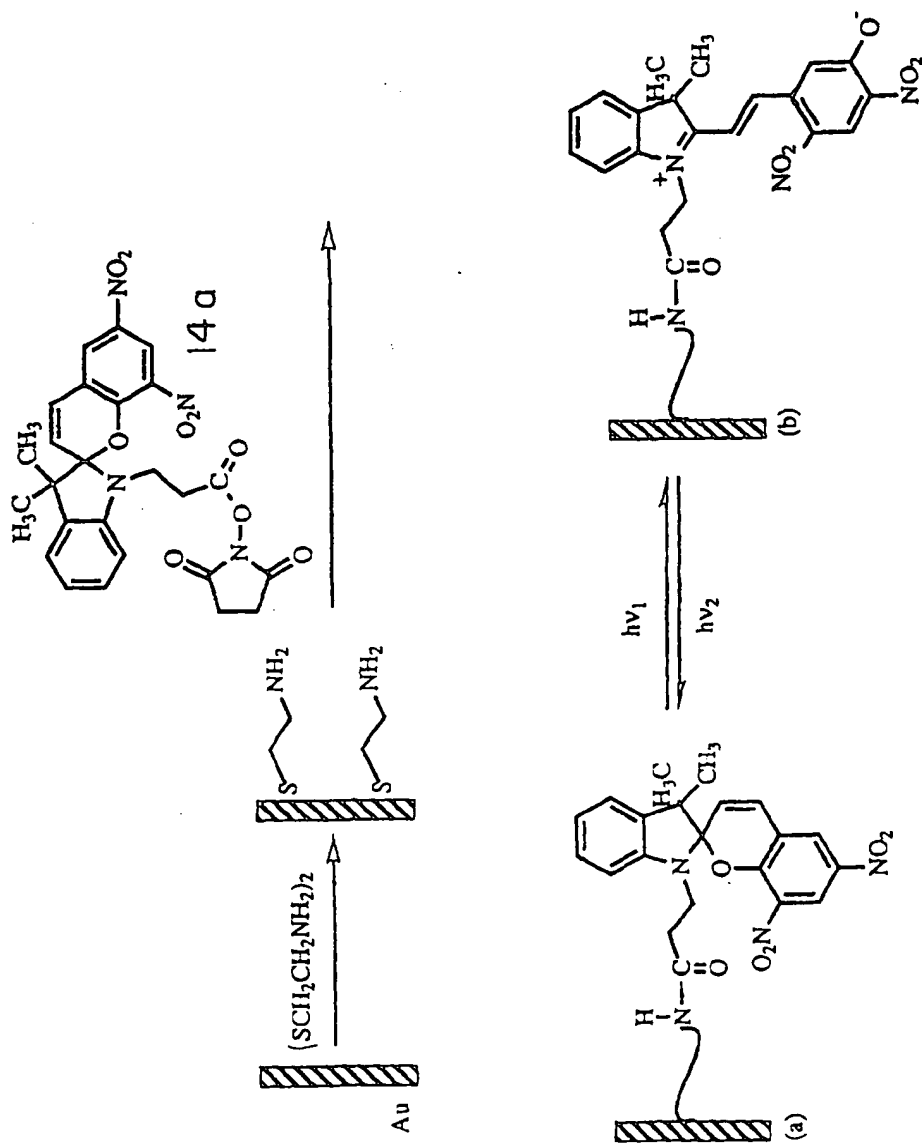

Fig. 25

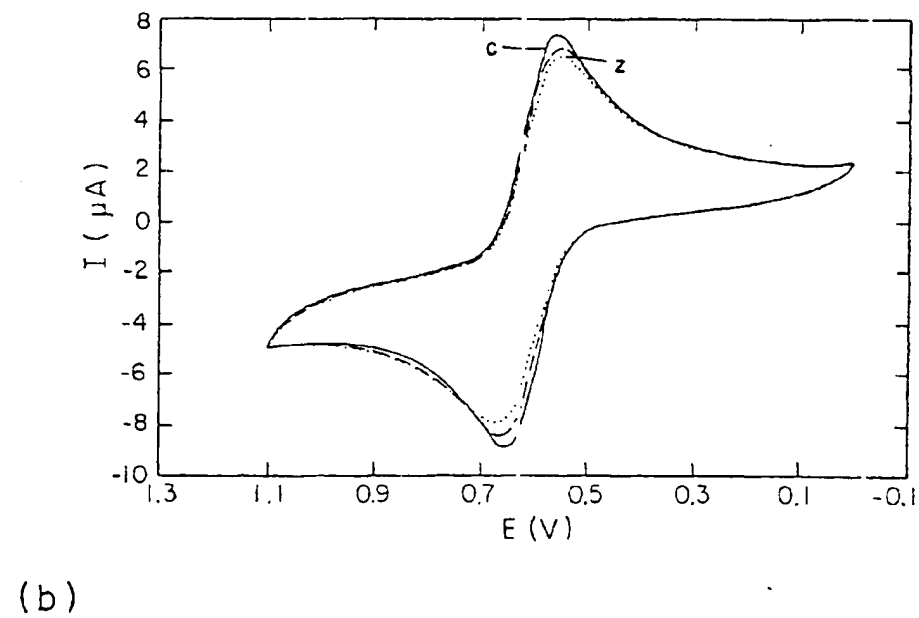
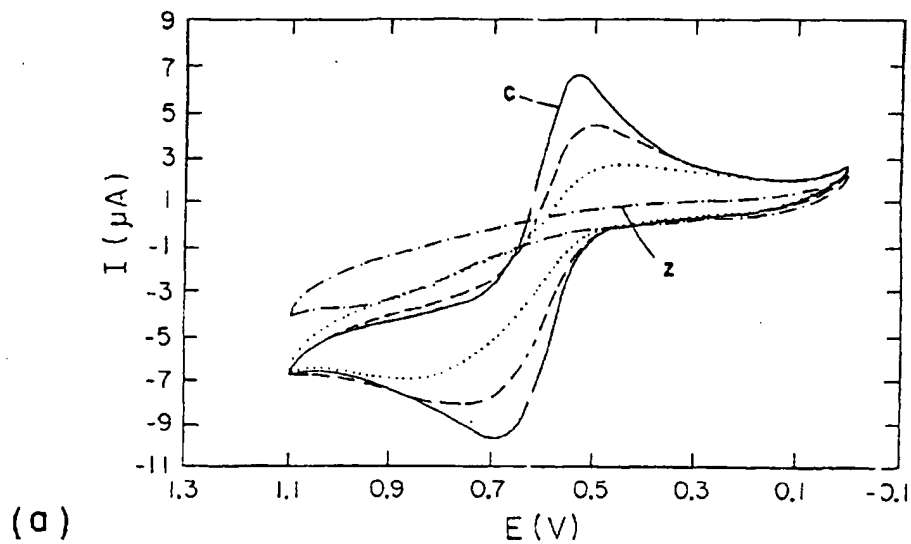

Fig. 26

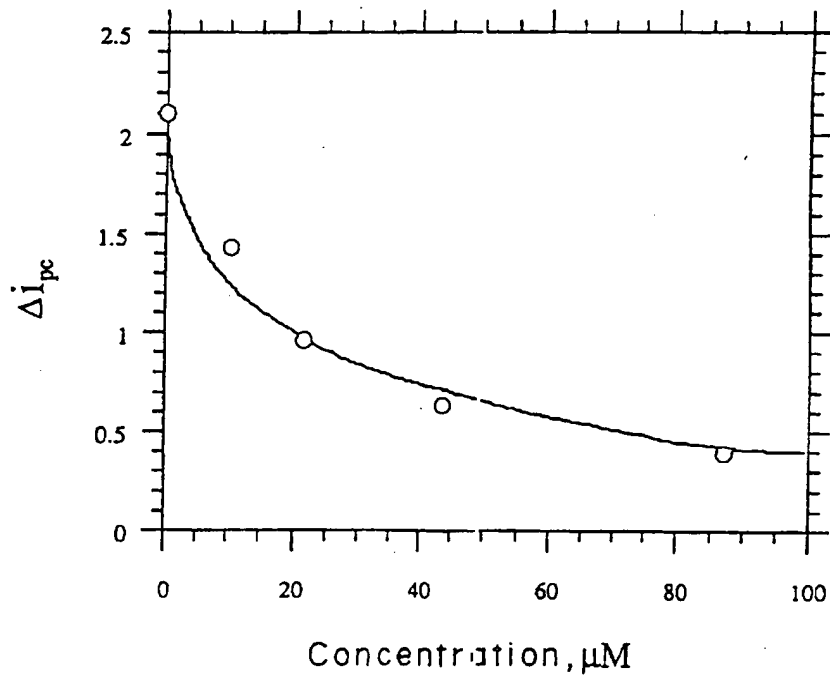

Fig. 27

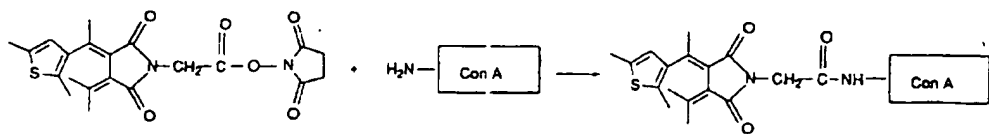

Fig. 28

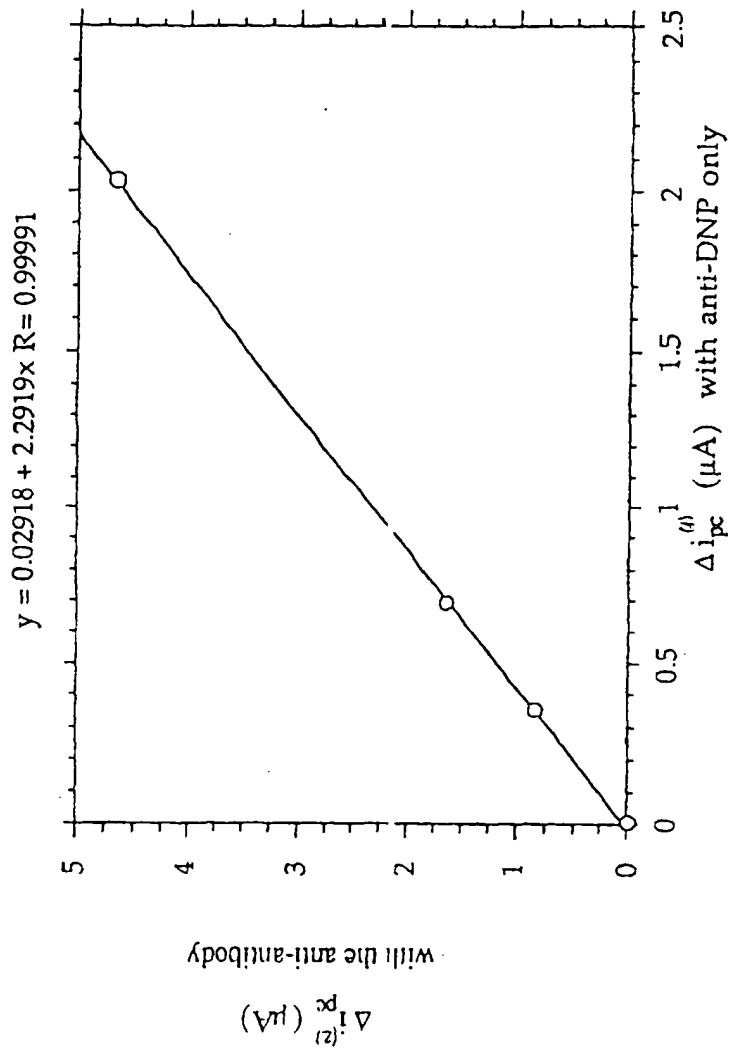
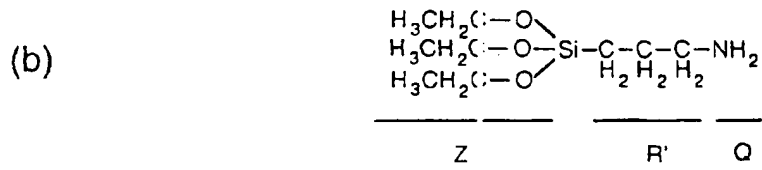
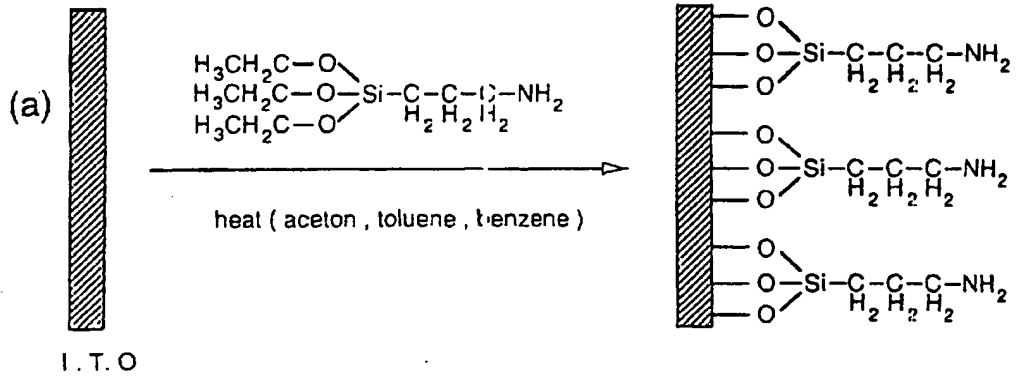

Fig. 29



3 - Aminopropyltriethoxysilane

I. T. O - Indium tin oxide

Fig. 30